



**Control & Security System**

# **Installation Manual**

Document Number 20100-2 Rev. 2.4  
May, 2003



**Home Automation, Inc.**



**Installation Manual**

**Document Number 20100-2 Rev. 2.4**

**May, 2003**

**Copyright © 2001-2003 Home Automation, Inc.  
All Rights Reserved**

# CONTENTS

<b>INTRODUCTION</b> .....	<b>1</b>
<b>PLANNING</b> .....	<b>1</b>
<b>INSTALLATION</b> .....	<b>2</b>
<b>CONTROLLER HOOKUP</b> .....	<b>2</b>
<b>ABOUT SECURITY ZONES</b> .....	<b>4</b>
BURGLAR ZONE HOOKUPS.....	4
<b>ABOUT FIRE ZONES</b> .....	<b>6</b>
TWO-WIRE SMOKE DETECTORS.....	6
FOUR-WIRE SMOKE DETECTORS.....	6
<b>TELEPHONE CONNECTIONS</b> .....	<b>9</b>
<b>LCD CONSOLE HOOKUP</b> .....	<b>11</b>
<b>CONSOLE SETUP</b> .....	<b>11</b>
CONSOLE ADDRESS.....	11
SOUNDER.....	11
KEY CLICK.....	11
KEY BACKLIGHT.....	11
VIEWING ADJUSTMENT.....	11
LANGUAGE.....	12
EXIT SETUP MODE.....	12
<b>CONSOLE SELF TEST</b> .....	<b>12</b>
<b>SOUNDER OUTPUTS</b> .....	<b>14</b>
INTERIOR SOUNDER HOOKUP.....	14
EXTERIOR SOUNDER HOOKUP.....	14
<b>CONTROLLER OUTPUTS</b> .....	<b>16</b>
<b>RESET OUTPUTS</b> .....	<b>16</b>
<b>OUTPUT APPLICATIONS</b> .....	<b>16</b>
GENERAL PURPOSE SWITCHING APPLICATIONS.....	16
SOUNDER TRIGGERING.....	16
COMMUNICATOR OUTPUTS.....	17
"ARMED" AND "OK TO ARM".....	17
SWITCHED OUTPUT.....	17
HAI COMMUNICATING THERMOSTATS.....	17
<b>HOME CONTROL MODULES</b> .....	<b>17</b>
<b>REMOTE ARM/DISARM SWITCH</b> .....	<b>17</b>
<b>HAI THERMOSTATS</b> .....	<b>19</b>
<b>PROGRAMMABLE ENERGY SAVER MODULES</b> .....	<b>20</b>
<b>TEMPERATURE, OUTDOOR TEMPERATURE, AND HUMIDITY</b> .....	<b>21</b>
<b>BUILT-IN SERIAL PORTS</b> .....	<b>23</b>
<b>BUILT-IN ETHERNET PORT</b> .....	<b>24</b>
CONTROLLER IP ADDRESS, PORT NUMBER, AND ENCRYPTION KEY.....	24
CONTROLLER IP ADDRESS.....	25
CONTROLLER PORT NUMBER.....	25
ENCRYPTION KEY.....	25
OMNIPRO II ETHERNET CONNECTIONS.....	25
CONNECTING TO NETWORK VIA PC ACCESS.....	26
<b>SYSTEM POWER UP PROCEDURE</b> .....	<b>28</b>
<b>CONSOLE CHECK OUT</b> .....	<b>28</b>
<b>TELEPHONE CHECK OUT</b> .....	<b>28</b>
<b>BURGLAR ZONE CHECK OUT</b> .....	<b>29</b>
<b>FIRE ZONE CHECK OUT</b> .....	<b>29</b>
<b>HOME CONTROL CHECKOUT</b> .....	<b>29</b>
<b>CUSTOMER CHECKOUT</b> .....	<b>30</b>
<b>IN CASE OF TROUBLE</b> .....	<b>30</b>
CONSOLES.....	30
CONTROLLER.....	30

<b>DIGITAL COMMUNICATOR.....</b>	<b>32</b>
DESCRIPTION OF CONTACT ID.....	32
DESCRIPTION OF 4/2 FORMAT .....	32
3/1 FORMAT .....	33
OPENING AND CLOSING REPORTS .....	33
<b>INSTALLER SETUP.....</b>	<b>34</b>
SETUP CONTROL .....	34
X-10 HOUSE CODE .....	34
X-10 3-PHASE.....	34
OUTPUT TYPES .....	35
<b>SETUP ZONES.....</b>	<b>36</b>
ZONE EXPANSION .....	36
ZONE RESISTORS.....	36
ZONE TYPES .....	37
LATCHING ZONE TYPES .....	38
DESCRIPTION OF ZONE TYPES.....	38
<b>SETUP DIGITAL COMMUNICATOR.....</b>	<b>41</b>
FIRST PHONE NUMBER, FIRST ACCOUNT NUMBER .....	41
COMMUNICATOR TYPE .....	41
TWO-WAY AUDIO.....	41
REPORT OPEN/CLOSE .....	42
AUTOMATIC TEST TIME .....	42
ALARM CODES (4/2 and 3/1 Formats) .....	42
<b>SETUP AREAS.....</b>	<b>43</b>
SETUP AREAS: CONTROL .....	43
SETUP AREAS: ZONES .....	44
SETUP AREAS: BUTTONS.....	45
SETUP AREAS: CONSOLES .....	45
SET-UP AREAS: THERMOSTATS.....	46
SETUP AREAS: MESSAGES .....	46
<b>SETUP TEMPERATURES .....</b>	<b>47</b>
TEMPERATURE DISPLAY .....	47
THERMOSTAT TYPE.....	47
<b>SETUP MISCELLANEOUS .....</b>	<b>48</b>
INSTALLER CODE.....	48
ENABLE PC ACCESS.....	48
PC ACCESS CODE.....	48
CALL BACK PHONE NUMBER.....	48
OUTSIDE SIREN DELAY .....	48
DIAL OUT DELAY .....	49
ALARM RESET TIME .....	49
ARMING CONFIRMATION.....	49
FIRE ALARM VERIFICATION .....	49
SUPERVISE INT SNDR.....	50
SUPERVISE EXT SNDR.....	50
ENABLE EMERGENCY KEYS .....	50
TIME DISPLAY.....	50
DATE DISPLAY .....	50
AC POWER FREQUENCY .....	50
DEAD LINE DETECT .....	50
OFF HOOK DETECT .....	50
PICKUP AFTER HANGUP .....	51
CLOCK ADJUSTMENT.....	51
MODEL AND SOFTWARE VERSION .....	51
RESET SYSTEM EEPROM .....	51
RESET SYSTEM RAM .....	51
ETHERNET MAC ADDRESS.....	51
SETUP EXPANSION.....	52
MODULE 1 TYPE .....	52

MODULE 2 TYPE - MODULE 4 TYPE .....	52
SERIAL 1 RATE .....	52
SERIAL 2 - SERIAL 3 RATE .....	52
SERIAL 1 FUNCTION .....	53
SERIAL 2 - SERIAL 3 FUNCTION .....	53
SERIAL 4 RATE .....	53
<b>OMNIPRO II SPECIFICATIONS.....</b>	<b>54</b>
<b>UNDERWRITER'S LABORATORIES (UL) INSTALLATION REQUIREMENTS .....</b>	<b>55</b>
<b>24-HOUR STANDBY BATTERY CAPACITY.....</b>	<b>56</b>
<b>SMOKE DETECTOR INSTALLATION GUIDELINES .....</b>	<b>57</b>
<b>APPENDIX A – CONTACT ID REPORTING FORMAT.....</b>	<b>58</b>
<b>APPENDIX B - DIGITAL COMMUNICATOR CODE SHEET .....</b>	<b>59</b>
<b>APPENDIX C - ZONE AND UNIT MAPPING.....</b>	<b>64</b>

## FIGURES

FIGURE 1 - CONTROLLER HOOKUP .....	3
FIGURE 2 - OVERALL CONNECTIONS DIAGRAM .....	5
FIGURE 3 - TWO-WIRE FIRE ZONE CONNECTIONS .....	7
FIGURE 4 - FOUR-WIRE FIRE ZONE CONNECTIONS .....	8
FIGURE 5 - RJ31X JACK CONNECTIONS.....	10
FIGURE 6 - CONSOLE CONNECTIONS .....	13
FIGURE 7 - SOUNDER CONNECTIONS .....	15
FIGURE 8 - RESETTING CONTROLLER OUTPUTS .....	16
FIGURE 9 - REMOTE KEYSWITCH CONNECTIONS .....	18
FIGURE 10 - HAI THERMOSTAT CONNECTIONS .....	19
FIGURE 11 - TEMPERATURE / HUMIDITY SENSOR CONNECTIONS .....	21
FIGURE 12 - PESM CONNECTIONS .....	22
FIGURE 13 - RS-232 CONNECTIONS.....	23
FIGURE 14 - RS-485 CONNECTIONS.....	24
FIGURE 15 - LOCAL NETWORK.....	26
FIGURE 16 - LOCAL / WIDE AREA NETWORK .....	27
FIGURE 17 - 24-HOUR STANDBY CONNECTIONS .....	56

# INTRODUCTION

This installation guide is intended as an aid to installing the OmniPro II Control & Security System. The installer should also have thoroughly reviewed and understood the OmniPro II Owner's Manual, which has important information regarding final setup of the system. This manual assumes that the installer has a basic understanding of installing a security system.

This guide applies to the 20A00-2, -5, and -22 versions of the OmniPro II series controller. Refer to the Underwriters Laboratories Installation Requirements section for details in the application of each. Failure to install the OmniPro II and its accessories in accordance with the UL Requirements in this manual and in the Owner's Manual, is a violation of the Listing Mark.

## PLANNING

Before you start, your system should be planned as follows:

1. Zones:
  - Decide where each contact or detector will be located
  - Decide which zone it will occupy
  - Decide zone type for each zone
  - Decide what area will be assigned
  - With the customer, decide what text and voice descriptors will be used. Consult table of voice descriptors, so that you can choose similar words for the text to avoid customer confusion.
  - See SMOKE DETECTOR INSTALLATION GUIDELINES to plan locations for smoke detectors
2. Consoles:
  - Consult the customer on the console location. The console should be easily accessible.
3. Interior Sounder and Outside Siren:
  - Locate both where they cannot be tampered with.
4. Lighting and Appliance Switches and Modules.
5. Plan for thermostats, energy saver modules, or other options.
6. Give consideration to where the controller will go. Remember that it needs a duplex receptacle not controlled by a switch, preferably on its own circuit, within 5 feet of the controller.

## INSTALLATION

Go over your plan with your customer.

1. Install the entire system. Refer to sections in this manual to see how to install various components.
2. Follow the Power-Up and Checkout procedures.
3. Explain the basics to the customer. Deliver all manuals and documentation.
4. Follow up with your customer to keep them satisfied.

## CONTROLLER HOOKUP

1. When choosing a place to mount the controller, consider the following:
  - a. A duplex outlet, preferably on its own circuit, is required to be within 5 feet of the controller for the power transformer and the X-10 Control Module.
  - b. The controller should be protected from weather, temperature extremes, and burglars.
2. **GROUND THE CONTROLLER "EARTH GND" TERMINAL TO A COLD WATER PIPE OR TO A 4-FOOT GROUND ROD TO PRESERVE ITS BUILT-IN TRANSIENT PROTECTION. USE 14 GAUGE WIRE. TRANSIENT PROTECTION WILL NOT WORK IF THE CONTROLLER IS NOT PROPERLY GROUNDED.**
3. Connect the 24 VAC power transformer to the 24 VAC INPUT terminals.
4. Connect the BLACK battery wire to the minus (-) terminal on the battery. DO NOT connect the red wire at this time. DO NOT reverse the connections; the battery fuse will blow. Note that the unit will NOT START on the battery alone.
5. Plug the X-10 Interface Module into the outlet above the transformer. Use the supplied 4-conductor modular telephone cable to connect the module to the jack on the processor board. The red LED on the interface module should be on and will blink off when the interface receives a signal from the controller.
6. Refer to **FIGURE 1 (CONTROLLER HOOKUP)** for this configuration.



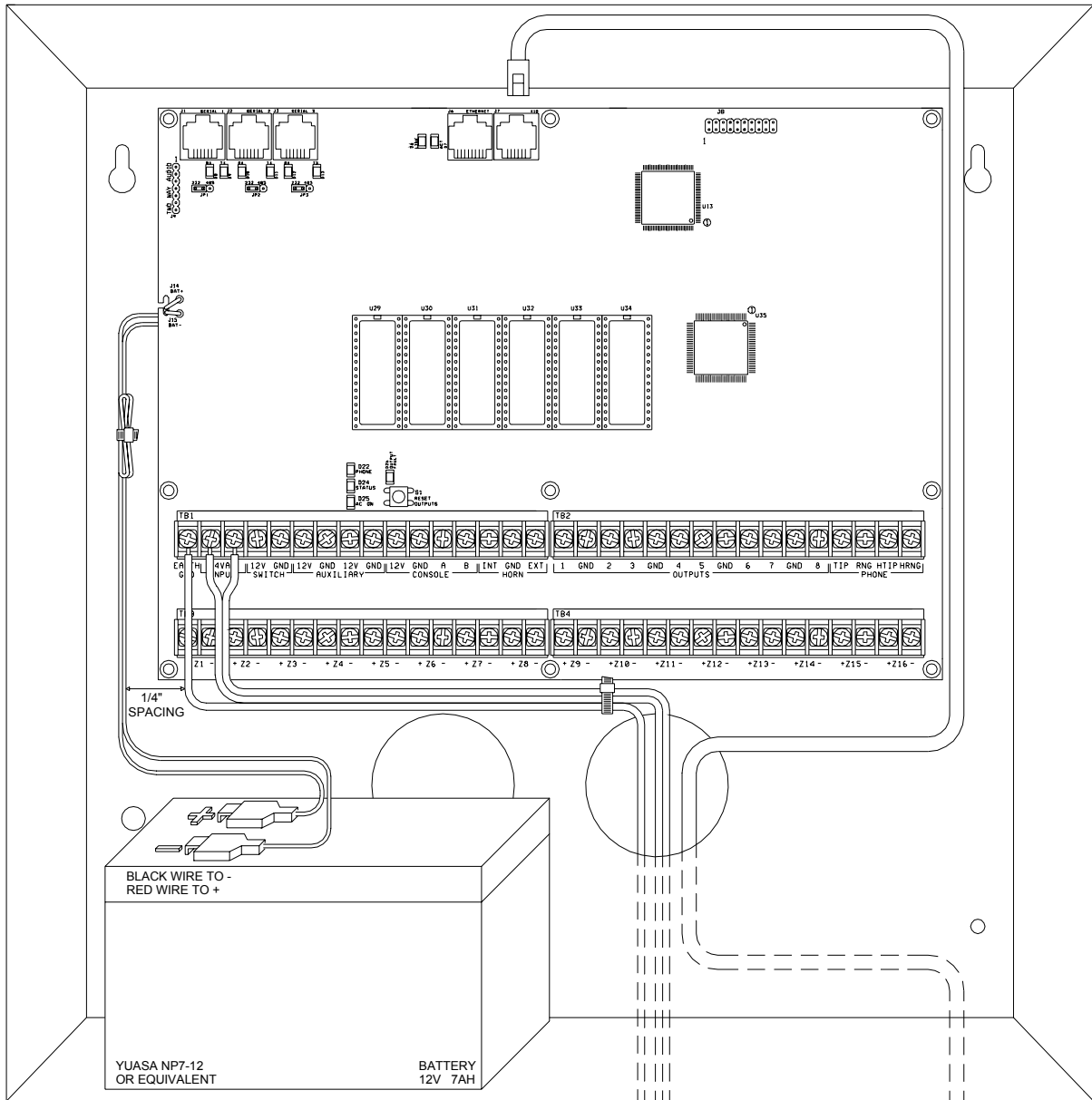

THE BATTERY IS NON-POWER LIMITED. THE BATTERY LEADS MUST BE SEPARATED FROM ALL OTHER POWER LIMITED/CLASS II WIRING IN THE ENCLOSURE BY AT LEAST 1/4"

COLD WATER PIPE OR GROUND ROD

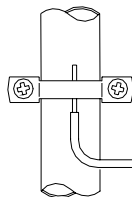

GROUNDING METHOD MUST BE IN ACCORDANCE WITH THE NATIONAL ELECTRIC CODE, ANSI/NFPA 70.

POWER TRANSFORMER

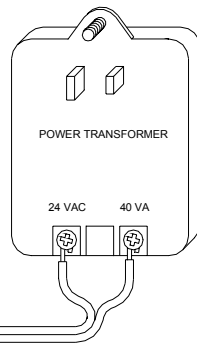

REVERE MODEL RT-2440SL OR EQUIVALENT

TWO-WAY POWER LINE INTERFACE

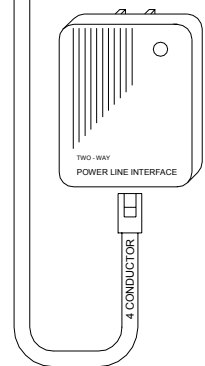

**FIGURE 1 - CONTROLLER HOOKUP**

## ABOUT SECURITY ZONES

Each of the 176 security zone inputs on an OmniPro II system may be configured as a burglary zone, a fire zone, a temperature zone, or an auxiliary input. Zones 1-4, however, are the only inputs that can be used with 2-wire smoke detectors. Zones 9-16 (on the controller) and Zones 49-176 (on expansion enclosures) are the only inputs that can be configured as a PESM.

An external 1000-ohm end-of-line zone resistor is required for all zones unless the Setup item ZONE RESISTERS is set to "No". If the Setup item ZONE RESISTORS is disabled, all zones other than Supervised Fire and Gas (and all zone inputs on Expansion Enclosures) will not use an end-of-line resistor. In this configuration, all zone switches (other than Supervised Fire and Gas) must be normally closed (open for alarm). If any zone requires a normally open (closed for alarm) switch (other than Supervised Fire and Gas), the Setup item ZONE RESISTORS must be set to "Yes" and all zones will require an external 1000-ohm end-of-line resistor.

The zone type for each zone is selected through the OmniPro II SETUP menu or by using the PC ACCESS software.

The system supports a maximum zone resistance, excluding the end-of-line resistor, of 150 ohms. The default setting for ZONE RESISTORS is "Yes". The default settings for all zone inputs on an OmniPro II controller are configured as Auxiliary inputs.

OmniPro II can be expanded to 176 zones by adding two 16 Zone Hardwire Expander Modules and up to eight 16 Zone Expansion Enclosures or Wireless Receivers.

## BURGLAR ZONE HOOKUPS

The OmniPro II system supports both normally open and normally closed switches. Most contacts designed for doors, windows, motion detectors, glassbreak detectors and other security devices meet this requirement. An external 1000-ohm end-of-line resistor must be used for all burglary zones if ZONE RESISTORS is set to "Yes".

1. When using a normally open switch, a 1000-ohm end-of-line resistor must be in parallel with the zone being used. Maximum loop resistance excluding end-of-line resistor should not exceed 150 ohms. ZONE RESISTORS must be set to "Yes".
2. When using a normally closed switch, a 1000-ohm end-of-line resistor must be put in series with the zone being used if ZONE RESISTORS are set to "Yes". If ZONE RESISTORS are set to "No", the 1000-ohm end-of-line resistor is not used. Maximum loop resistance excluding end-of-line resistor should not exceed 150 ohms.

**Note:** The 1000-ohm end-of-line resistor is required on all zone inputs on Expansion Enclosures.

3. Power motion detectors from AUXILIARY 12V.
4. Unused zones may be left open, and should be left at the default setting of AUXILIARY zone types.
5. When Zones 1-4 are configured to anything other than a Supervised Fire or Gas zone, the corresponding Zone Jumpers (JP11-JP14) must be in the NRM (normal) position.
6. See **FIGURE 2 (OVERALL CONNECTIONS DIAGRAM)** for configurations of burglary zones.

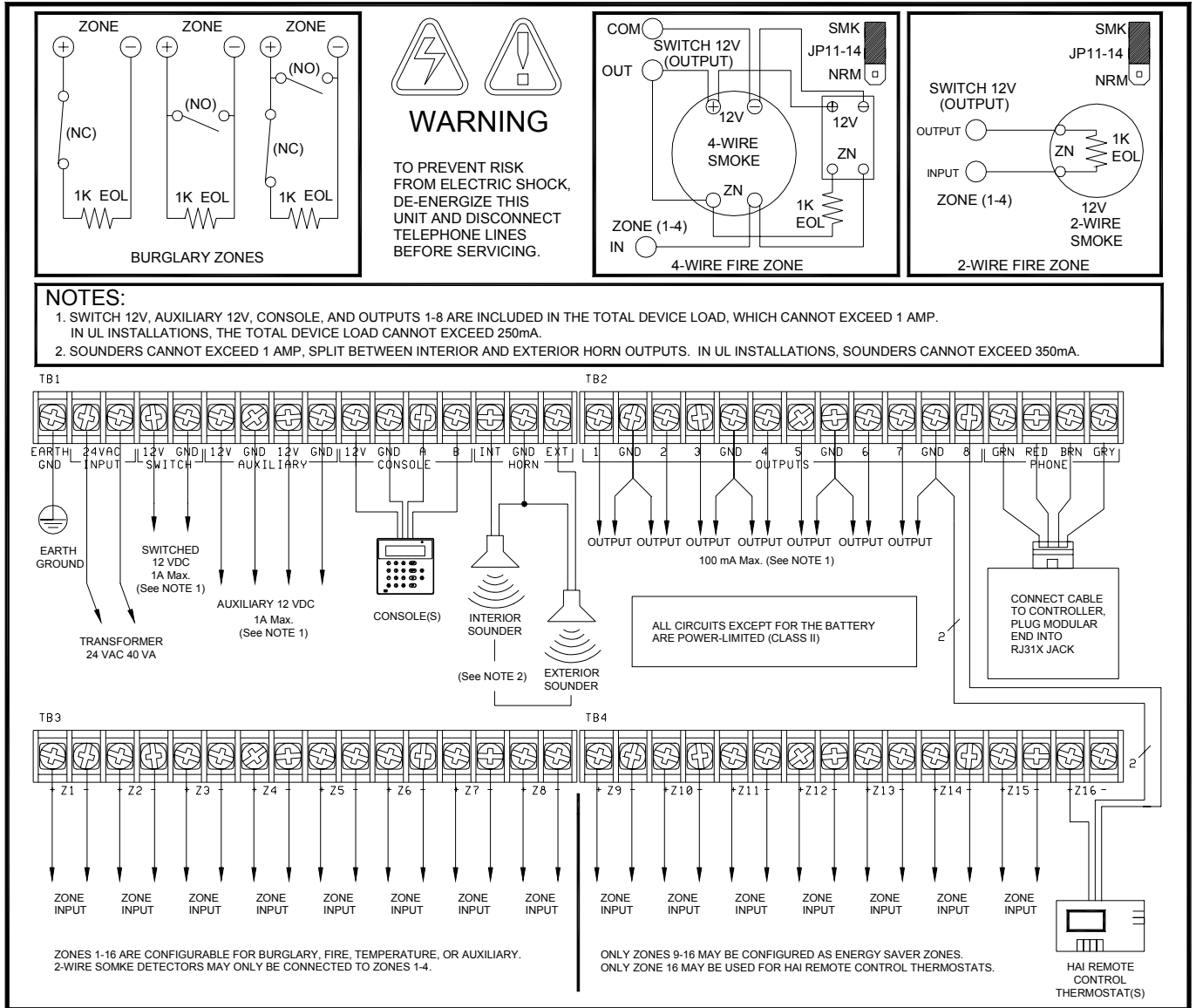

**FIGURE 2 - OVERALL CONNECTIONS DIAGRAM**

## ABOUT FIRE ZONES

The OmniPro II system supports normally open (closed for alarm), two-wire or four-wire smoke detectors. Two-wire smoke detectors can only be connected to Zones 1-4. Four-wire smoke detectors can be connected to any zone. An external 1000-ohm end-of-line resistor must be used for all fire (and gas) zones. When Zones 1-4 are configured as a Supervised Fire (two-wire or four-wire) or Gas zone, the corresponding Zone Jumpers (JP11-JP14) must be in the "SMK" (smoke) position. Zone Jumper "JP11" corresponds to Zone 1, "JP12" corresponds to Zone 2, "JP13" corresponds to Zone 3, and "JP14" corresponds to Zone 4.

1. Smoke detectors must be powered from SWITCH 12V or an Output configured as a SWITCHED POWER OUTPUT.
2. End of line resistor: 1000 ohms. Maximum loop resistance EXCLUDING end of line resistor is a 150 ohms. Use HAI Model 1503A0011 End of Line Resistor Assembly in UL Listed Installations.
3. Smoke detectors are reset when the security system is armed.

## TWO-WIRE SMOKE DETECTORS

OmniPro II supports two-wire smoke detectors connected to Zones 1-4.

1. Use normally open (closed for alarm) two-wire "SYSTEM" type smoke detectors (System Sensor 2100TS or equivalent), rated 8 - 14 VDC. In UL installations, the System Sensor 2100 series 2-wire smoke detectors must be used.
2. Smoke detectors must be connected to Zones 1-4 and configured as a Supervised Fire Zone. A maximum of 10 2-wire smoke detectors can be connected to each zone.
3. An external 1000-ohm end-of-line resistor must be used.
4. Connect to the SWITCH 12V or an Output configured as a SWITCHED POWER OUTPUT.
5. The corresponding Zone Jumpers (JP11-JP14) must be in the SMK (smoke) position.
4. Refer to **FIGURE 3 (TWO-WIRE FIRE ZONE CONNECTIONS)** for this configuration.

Smoke detector compatibility identifier: A

## FOUR-WIRE SMOKE DETECTORS

OmniPro II supports four-wire smoke detectors connected to any zone (1-176).

1. Use normally open (closed for alarm) four-wire "SYSTEM" type smoke detectors (System Sensor 2112/24TR or equivalent), rated 8 - 14 VDC.
2. An End of Line Power Supervision Relay Module (System Sensor A77-716B or equivalent) is required for UL installations. Install 1000-ohm end-of-line resistor as shown.
3. Power the smoke detector from SWITCH 12V or an Output configured as a SWITCHED POWER OUTPUT.
4. When connected to Zones 1-4, the appropriate Zone Jumper (JP11-JP14) must be in the SMK (smoke) position.

**NOTE:** Smoke detectors connected to Zones 1-4 are wired differently from those connected to Zones 5-176.  
Refer to **FIGURE 4 (FOUR-WIRE FIRE ZONE CONNECTIONS)** for each configuration.

WHEN Z1-Z4 IS CONFIGURED AS A SUPERVISED FIRE OR GAS ZONE, THE CORRESPONDING ZONE JUMPERS J11-J14 MUST BE IN "SMK" POSITION

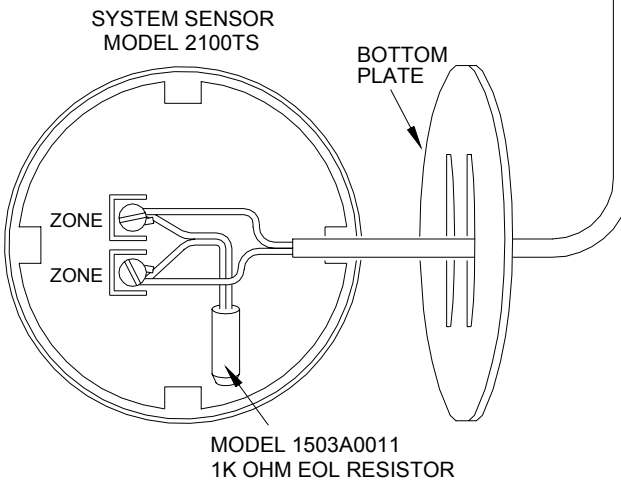
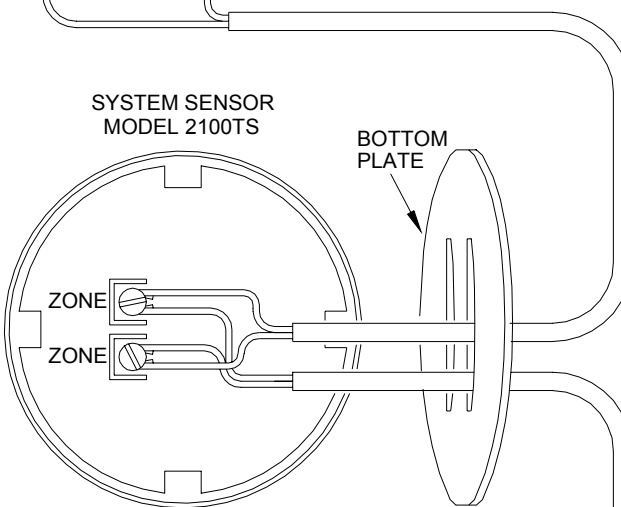
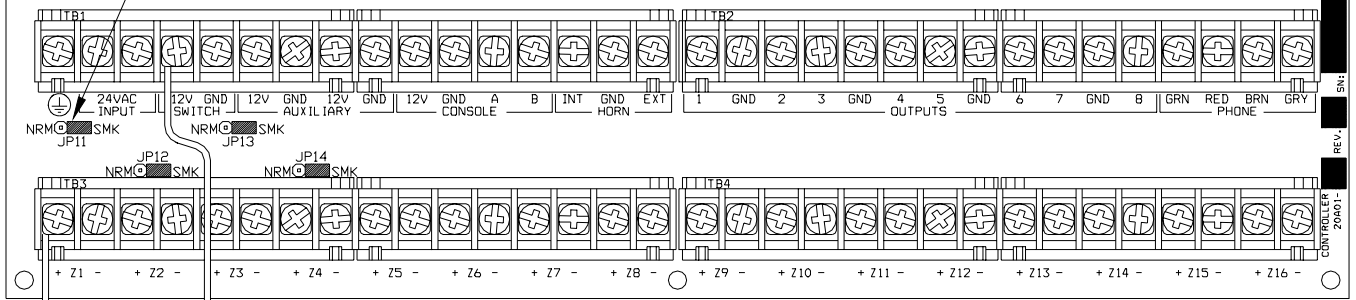

**FIGURE 3 - TWO-WIRE FIRE ZONE CONNECTIONS**

WHEN Z1-Z4 IS CONFIGURED AS A SUPERVISED FIRE OR GAS ZONE, THE CORRESPONDING ZONE JUMPERS J11-J14 MUST BE IN "SMK" POSITION

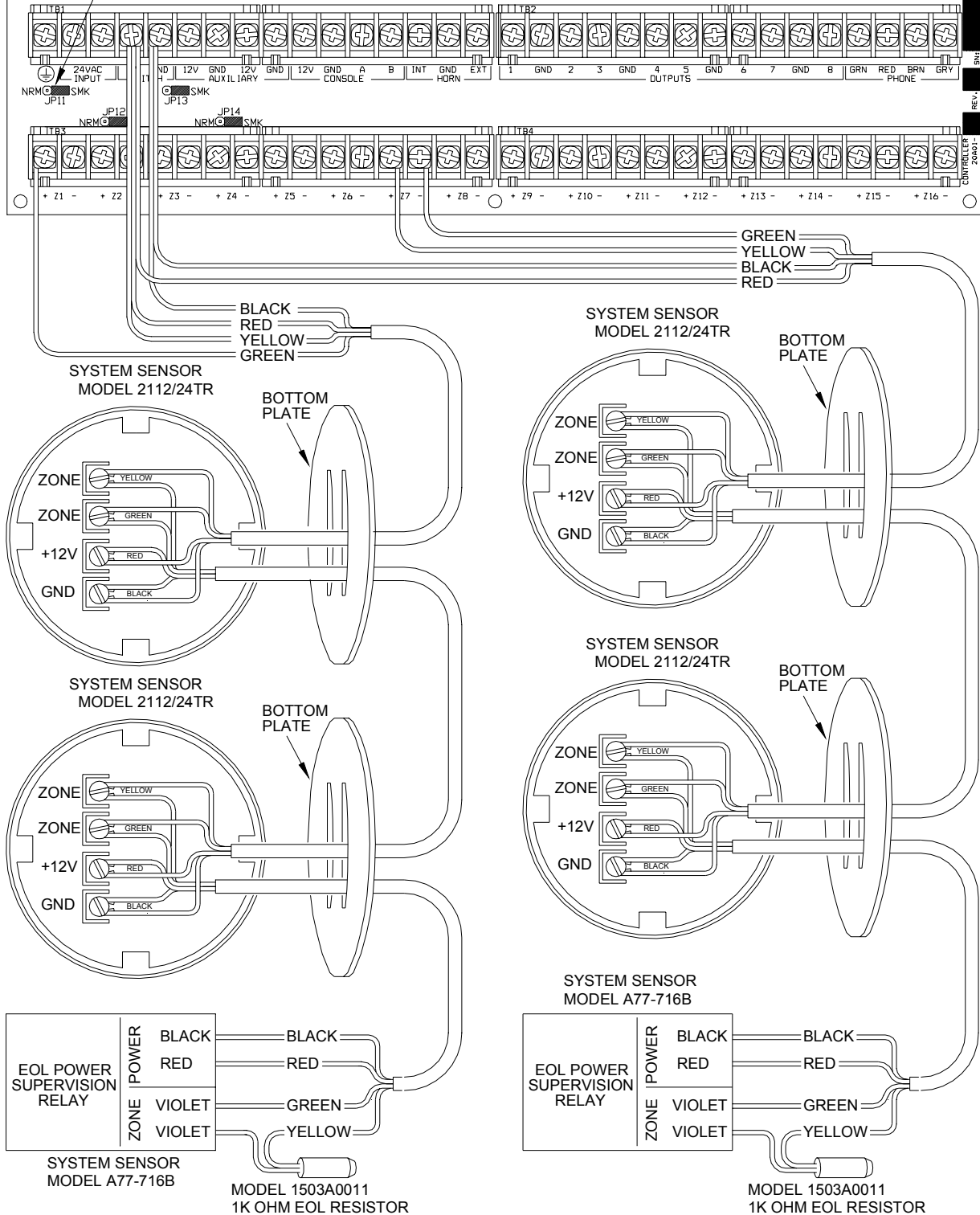

FOUR-WIRE DETECTORS ON ZONES 1-4

FOUR-WIRE DETECTORS ON ZONES 5-16

**FIGURE 4 - FOUR-WIRE FIRE ZONE CONNECTIONS**

## TELEPHONE CONNECTIONS

1. If an RJ31X jack has been supplied by the telephone company, it is probably wired correctly and the controller can be connected by plugging the supplied 8 conductor telephone cable into the RJ31X jack. The other end of the cable is spaded. The green, red, brown, and gray wires must be connected to the controller at the designated terminals under the section of the board marked 'PHONE'.
2. If required, install the supplied RJ31X jack as shown in the following diagram. The polarity must be correct for proper operation of the phone access feature.
3. IT IS IMPERATIVE THAT THE PHONE LINE COMING INTO THE HOUSE BE CONNECTED TO A GROUNDED SURGE ARRESTOR OUTSIDE THE PREMISES. IT IS THE RESPONSIBILITY OF THE TELEPHONE COMPANY TO PROVIDE THIS SURGE ARRESTOR.
4. INSPECT THE INCOMING PHONE LINES. THE FIRST THING THAT THEY SHOULD GO TO IS A SMALL BOX ON THE OUTSIDE OF THE PREMISES. THERE SHOULD BE A HEAVY GROUND WIRE COMING FROM THIS BOX GOING TO A COLD WATER PIPE OR A SEPARATE GROUNDING ROD.
5. IF THERE IS NO SURGE ARRESTOR OR IF THE GROUND WIRE IS MISSING, HAVE THE CUSTOMER INSIST THAT THE TELEPHONE COMPANY INSTALL ONE FOR THE SAFETY OF THE CUSTOMER.
6. WHEN WIRING A RJ31X JACK, MAKE SURE THAT THE INCOMING PHONE LINES GO TO THE TELEPHONE COMPANY SURGE ARRESTOR BEFORE THEY GO TO THE RJ31X JACK.
7. When the RJ31X is installed as shown, locate the green, red, brown, and gray spaded wires from the 8 conductor phone cable and connect to the section on the OmniPro II controller marked 'PHONE'. Plug the modular end of the cable into the RJ31X jack. If necessary, bend the tab up on the plug to ensure a tight fit that will not fall out.
8. Verify the following if you have trouble during check out: With the system running, the RJ31X jack properly connected and all phones on-hook (hung up), the PHONE LED, located in the upper left corner of the controller, should be OFF. If it is on, reverse the RED and GREEN wires to both the house phones and the telephone company wires at the RJ31X jack. When the receiver is picked up on any phone, the PHONE LED will come on. When the phone line rings, the PHONE LED will light.
9. If the OmniPro II is accessed on an in house telephone, the OmniPro II will disconnect the phones from the phone company lines and supply its own talk voltage to the phones. The PHONE LED will be on in this case.
10. Refer to **FIGURE 5 (RJ31X JACK CONNECTIONS)** for this configuration.

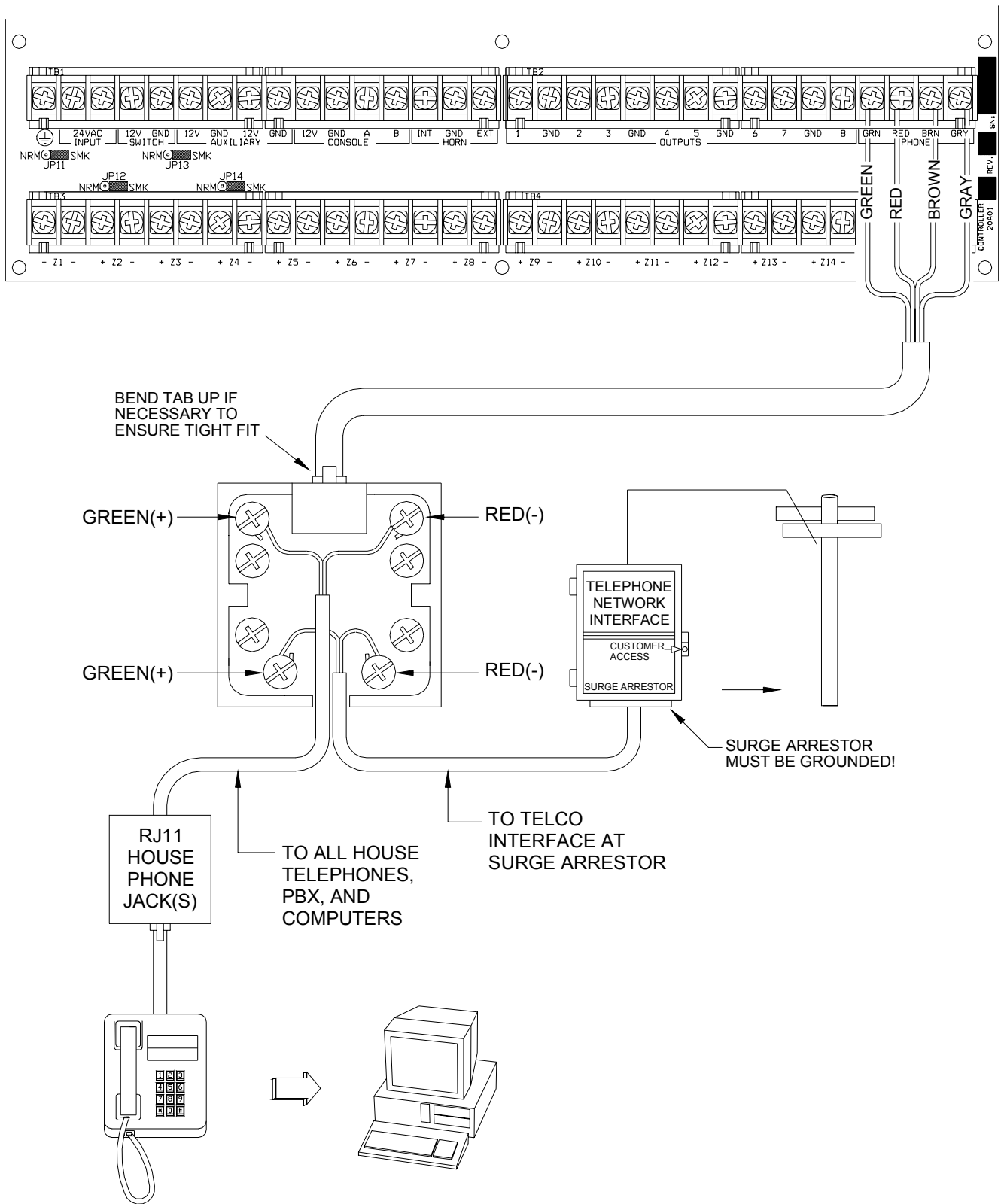

**FIGURE 5 - RJ31X JACK CONNECTIONS**



## LCD CONSOLE HOOKUP

1. 16 LCD Consoles (Models 11A00-1, 11A00-2, 11A00-9, and 15A00) MAXIMUM per system, subject to power availability.
2. Use 4-conductor 22-gage wire, 1000 feet maximum length. Consoles can be homerun or daisy chained. This length shall be divided by the total number of consoles at the end of the run. For example, for 8 consoles, the maximum length reduces to 125 feet. All LCD Consoles are connected to the same 4 wires, +12, GND, A, B.
3. The console should be mounted so that the LCD display is at or slightly above eye level. Consoles should be kept out of the reach of young children. A good height is approximately 58 inches from the floor to the bottom of the console enclosure.
4. Remove console face from back plate (slots on bottom of console will release back plate, use a screwdriver). Mount the back plate to the wall. Mounting holes are designed to fit on a single or double gang box, or directly to the wall. Pull the wires from the wall through the opening in the back plate. Splice the wires to the supplied cable. Connect the cable to the connector on the console board (J1). Snap the console face on to the back plate. Remove protective film from the LCD lens.
5. Refer to **FIGURE 6 (CONSOLE CONNECTIONS)** for this configuration.

## CONSOLE SETUP

The console has different operating options that can be setup from the console to the user's preference. If more than one console is being used, it is required that you give each console a different address. You can change the address of a console through the console setup mode.

To enter the console setup mode, simultaneously press and hold the 4 and up arrow (↑) for approximately 1 second. The console will beep 5 times and enter the setup mode. The top line of the display will indicate what you are doing, followed by the current setting. The bottom line will show a menu of your options. To the lower right corner of the display is the direction arrow(s). Where possible, the up (↑), down (↓), and two-headed (↕) arrow characters are shown on the console display to indicate which arrow keys may be pressed at that time. Press the down arrow (↓) key to advance to the next item. Press the up arrow (↑) key to go back to the previous item.

### CONSOLE ADDRESS

If you are installing more than one console, each console must be set to a different address. The default address setting is (1) - this is adequate if only one console is being used. The choices at the bottom are 1-16. When making your choice, choose an address between 1-16, then press the # (pound) key.

### SOUNDER

If you wish not to hear the beeper in the console for any reason, the sounder option can be turned off. Select (0) for OFF or (1) for ON, then press the # key.

### KEY CLICK

The sounder makes a click every time a key is pressed. This option may also be turned off. Select (0) for OFF or (1) for ON, then press the # key.

### KEY BACKLIGHT

The keys on the console keypad are lit. The keys can be never lit, always lit, or only lit when the LCD display is lit. Select (0) OFF, (1) for ON, or (2) TIMED, then press the # key.

### VIEWING ADJUSTMENT

This option is an adjustment for the viewing angle of the LCD display. This has been set to its best value at the factory, however, you may wish to tweak it. The display has 20 levels of adjustment. Select (1) for a lower viewing angle, or (2) for a higher viewing angle.

## **LANGUAGE**

This option is to display the 'console setup' text on the LCD display in English, French, Italian, or Spanish. Select one of the languages, then press the # key.

## **EXIT SETUP MODE**

To exit Setup Mode, press and hold the 4 and up arrow (↑) keys simultaneously for about 1 second. The console will return to normal operation. You may need to press (\*) to restore the display.

## **CONSOLE SELF TEST**

Use the self test mode to verify the proper operation of the console.

1. Disconnect the console from the controller. Connect +12 and GND terminals to a 12-volt source (or a fresh 9-volt transistor battery.) The console beeper will beep twice per second, the LCD backlight and the keypad key will be lit, and the LCD will display "NO CONTROLLER DATA".
2. Simultaneously press and hold the 7 and the down arrow (↓) keys for approximately 3 seconds. The beeper will beep 5 times, the LCD backlight and keypad backlight will turn off, and the display will clear. The LED at the top right corner of the console will start to cycle through its different colors (red, green, yellow, then turns off). At the end of each cycle the beeper will beep once.
3. Press any key. The LCD backlight and the keypad key backlight will turn on.
4. Press the keys in the following order and verify that the appropriate character fills the screen. 0 - 9, \*, #, AWAY (A), NIGHT (B), DAY (C), OFF (D), ↑ (filled blocks), and ↓ (blanks).
5. If this is successful, the console is good. Simultaneously press and hold the 7 and down arrow (↓) keys to exit the self test mode or disconnect power.

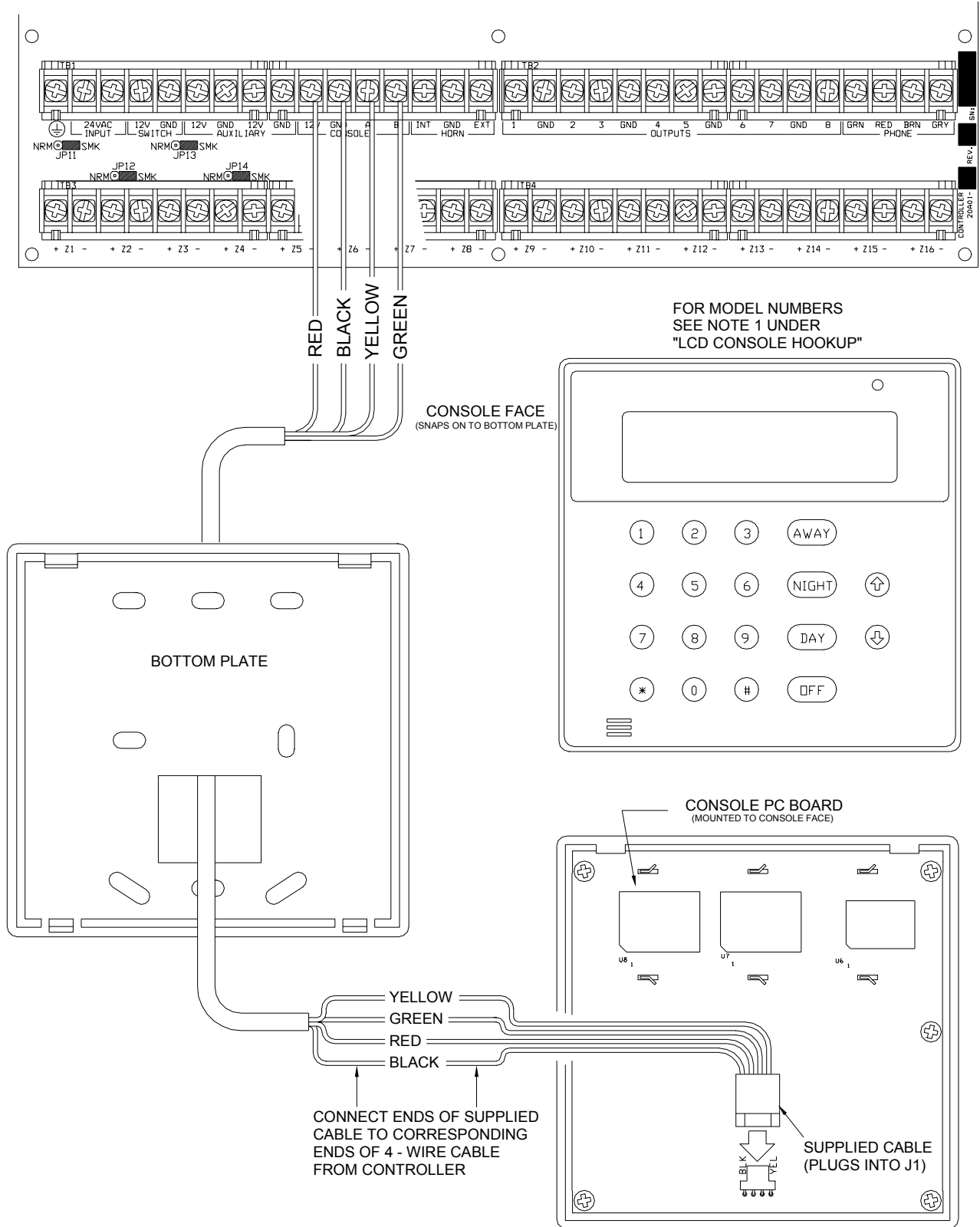

**FIGURE 6 - CONSOLE CONNECTIONS**

## **SOUNDER OUTPUTS**

The Horn Output provides 12VDC to power bells, piezo sirens, self-contained sirens, and siren drivers (do not connect speakers to the Horn Output). Sounders can draw up to 1 amp **MAXIMUM**, split between the Interior and Exterior Horn Outputs - (See Specifications for UL Ratings). Use a relay connected to an auxiliary power supply if higher current draw is required.

### **INTERIOR SOUNDER HOOKUP**

1. Locate the interior sounder in a central location. The sounder is very loud. Do not install it in a room where small children or animals could be trapped if the alarm is activated.
2. The Interior Horn Output monitors the wiring to bells and sirens. When enabled, it will report trouble and make a digital dial out when an open, short, or other wiring problem is detected in the supervised bell circuit. When violated, the following trouble is displayed on the console, "FIRE TAMPER TRBL NOW".
3. For UL Listed residential fire alarm applications, the UL Listed Wheelock Model MT-12/24-R Multitone Signal or equivalent must be used, and the "SUPERVISE INT SNDR" feature must be set to "ON".
4. Refer to **FIGURE 7 (SOUNDER CONNECTION)** for connections.

### **EXTERIOR SOUNDER HOOKUP**

1. If used, wire tamper switches to a tamper zone with a 1000-ohm end-of-line resistor.
2. The Exterior Horn Output monitors the wiring to bells and sirens. When enabled, it will report trouble and make a digital dial out when an open, short, or other wiring problem is detected in the supervised bell circuit. When violated, the following trouble is displayed on the console, "FIRE TAMPER TRBL NOW".
3. To enable supervision of the Exterior Horn Output, the "SUPERVISE EXT SNDR" feature must be set to "ON".
4. Refer to **FIGURE 7 (SOUNDER CONNECTION)** for connections.

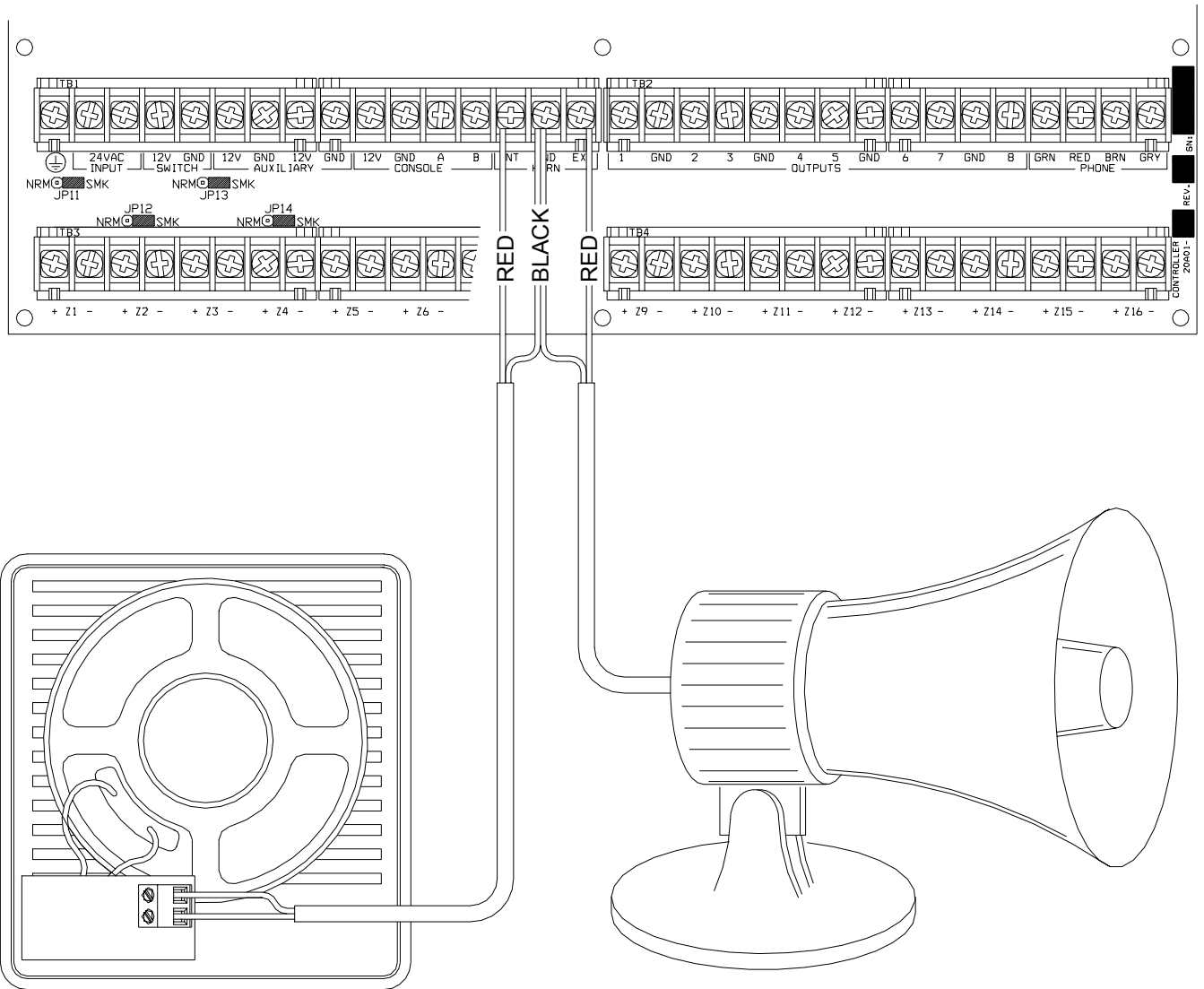

**FIGURE 7 - SOUNDER CONNECTIONS**

## CONTROLLER OUTPUTS

The OmniPro II provides 8 programmable hardwired voltage outputs and two horn voltage outputs. These outputs are programmable for the following output types:

- General Purpose low voltage switching applications (12 VDC) - Units 385 - 392
- Sounder triggering (a trigger for siren and voice drivers for BURG and FIRE)
- Communicator outputs (radio, cellular, or any other type of auxiliary communicator)
- 'ARMED' and 'OK TO ARM' outputs
- Switched Output (to power smoke detectors and cycle power to latching devices)

Outputs 1 - 8 can supply a **maximum** of 100 mA each. These outputs are included in the total DEVICES load, which cannot exceed 1A. If the Interior or Exterior Sounder is configured to an Output Type, the HORN outputs can supply a **maximum** of 1A. HORN outputs are included in the total HORNS load, which can not exceed 1A.

## RESET OUTPUTS

Outputs 1-8 are protected from an overload condition. If an overload condition occurs on an output, it will shut off (the output will supply 0V). When this occurs, the "Output Fault" (D26) LED (marked "A" if Figure 8) will illuminate. To reset the output, remove the device causing the overload condition, then press the "Reset Outputs" (S1) Switch (marked "B" if Figure 8).

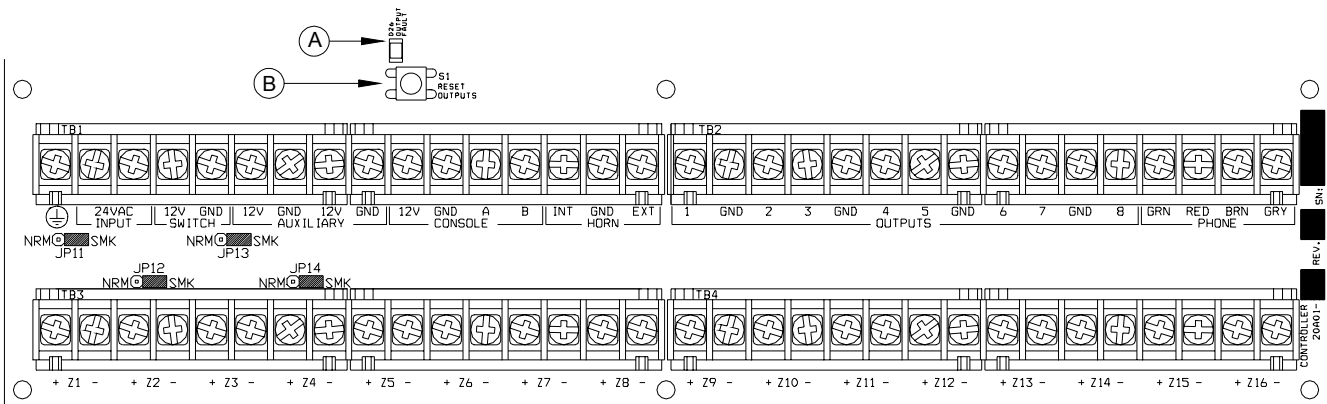

**FIGURE 8 - RESETTING CONTROLLER OUTPUTS**

## OUTPUT APPLICATIONS

### GENERAL PURPOSE SWITCHING APPLICATIONS

This output will supply 12 VDC to the output terminal when its corresponding unit is ON. Output 1 is designated Unit 385 through Output 8 which is Unit 392. This can be used to drive relays for many different applications, including switching sprinkler valves and low-voltage lighting.

### SOUNDER TRIGGERING

This output can be used as a trigger for siren and voice drivers. When a driver requires a separate input for burglary and fire, you can configure this output to give a voltage trigger to the driver. Also, each area can have its own sounder.

## COMMUNICATOR OUTPUTS

This output can be used for radio communications or any other type of auxiliary communications to augment the built-in digital and voice dialers. Any communications device can be used with the OmniPro II, provided that it is powered by 12 VDC, has 12 VDC triggered inputs, and has 2 (or more) channels.

The 'Communicator' outputs are activated 3 seconds before the OmniPro II dialer begins to dial either using its built-in digital dialer or voice dialer.

The following events will activate the BURG output: Burglar alarms (including panic zones), Auxiliary emergencies, Police emergencies, and Duress alarms. Fire alarms and the fire emergencies will activate the FIRE output.

### "ARMED" AND "OK TO ARM"

**ARMED:** When the system is armed in any of the security modes (AWAY, NIGHT, DAY, or VACATION), this output is active. It is typically used to activate a red LED to indicate that the system is 'armed'.

**OK TO ARM:** When all security zones are secure, no zones are bypassed, and the system is in the 'OFF' mode, this output is active. It is typically used to activate a green LED to indicate that the system is 'ok to arm'.

### SWITCHED OUTPUT

This output is used to cycle power to latching devices when the system is armed. This output will reset the smoke detectors when the system is armed after an alarm.

### HAI COMMUNICATING THERMOSTATS

When HAI RC-Series thermostats are used, Output 8 is used to communicate with up to 64 thermostats. There is no need to configure this output when used with HAI thermostats. It may be left at the default setting of "General Purpose".

## HOME CONTROL MODULES

Install X-10 or compatible modules EXACTLY as described in the instructions that come with each module. Watch the load ratings and types of load allowed. The OmniPro II is designed to send signals to any device compatible with the X-10 powerline carrier protocol

## REMOTE ARM/DISARM SWITCH

1. If desired, a remote keyswitch, keypad, or hidden arm/disarm toggle switch can be connected to the system. The device should have a momentary close type switch.
2. Configure one of the zone inputs as a KEYSWITCH INPUT zone. A closure of the switch contacts will toggle the arming mode between OFF and AWAY (Entry and Exit delays are still active).
3. Configure one of the outputs as an "ARMED" and another output as an "OK TO ARM" output. These outputs are used to activate a red or a green LED based on the state of the alarm system. The "ARMED" and "OK TO ARM" outputs can supply a **maximum** of 100 mA each. These outputs are included in the total DEVICES load, which cannot exceed 1 A.
4. Refer to **FIGURE 9 (REMOTE KEYSWITCH CONNECTION)** for this configuration.

NOTE: In UL Listed Installations, the Listed Ademco Model 9789 keyswitch shall be used.

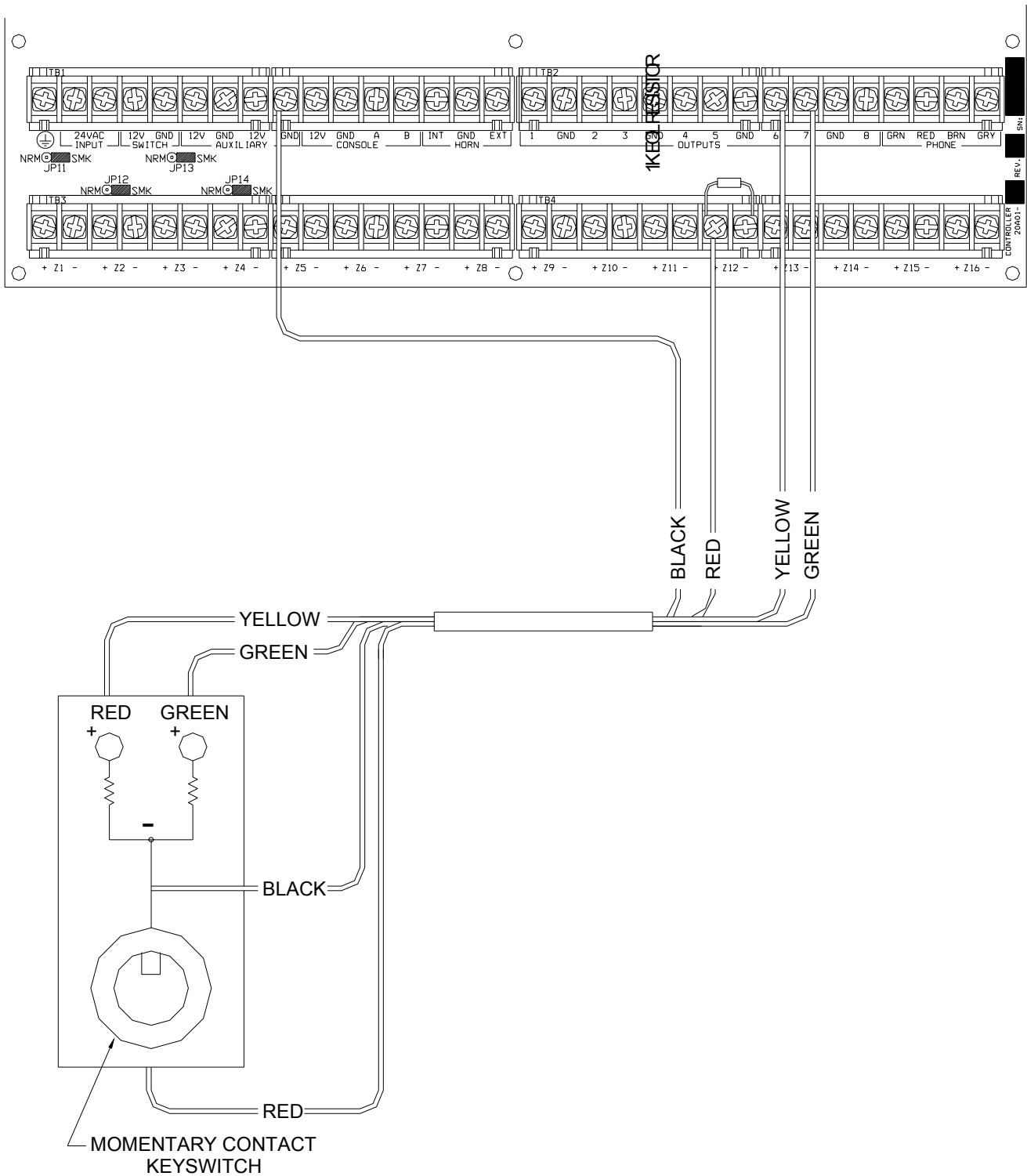

FIGURE 9 - REMOTE KEYSWITCH CONNECTIONS



# HAI THERMOSTATS

OmniPro II supports up to 64 HAI RC-Series Communicating Thermostats. The controller can send commands to the thermostat to change mode, cool setting, heat setting, status of fan and hold, and other items.

Run a 3 (or 4) conductor wire from OmniPro II to the thermostat location. All thermostats are connected in parallel to Zone 16 and Output 8. Connect the red COMM cable wire with the black COMM cable wire. Make the connections (as shown in Figure 10) using the supplied wire splices.

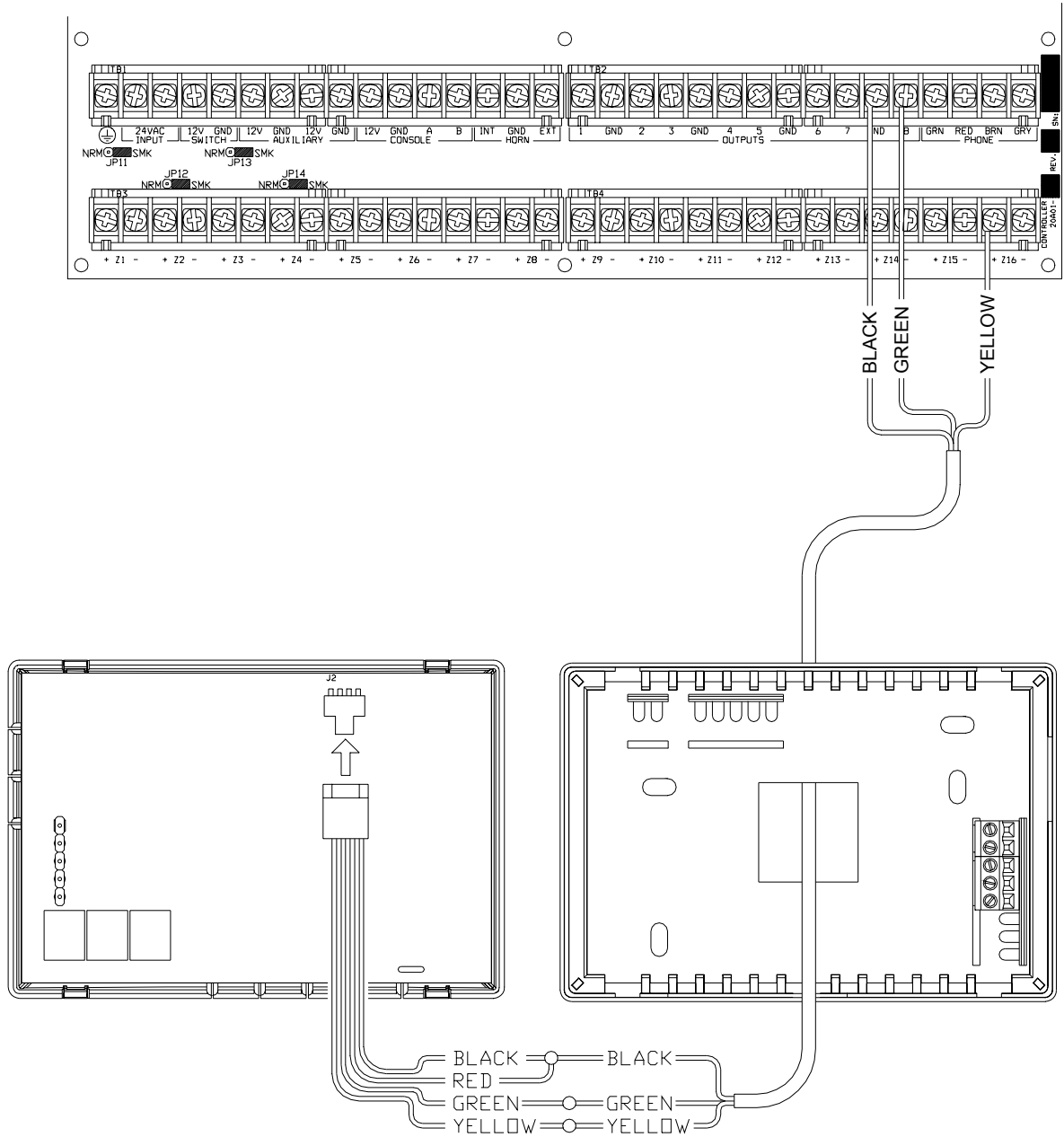

**FIGURE 10 - HAI THERMOSTAT CONNECTIONS**

## PROGRAMMABLE ENERGY SAVER MODULES

Programmable Energy Saver Modules may be connected to:

<b>Controller:</b>	<b>Zone 9 and Output 1</b>	<b>through</b>	<b>Zone 16 and Output 16, respectively</b>
<b>Expansion Enclosures:</b>	<b>Zone 1 and Output 1</b>	<b>through</b>	<b>Zone 16 and Output 16, respectively</b>

1. OmniPro II can support up to 136 Programmable Energy Saver Modules (PESM). Each PESH requires one security zone input and one controller output. The zone input corresponds to the controller output (Zone 9 and Output 1 through Zone 16 and Output 8, respectively). If Zone 9 is used, Output 1 must be used as its pair.
2. When setup as an Energy Saver Zone Type (Type 80), the zone and unit (output) is used as a pair to read in temperature and control the setback temperature of the house. Only zones 9-16 and 49-176 may be configured as an Energy Saver zone.
3. Run a 4-conductor wire from the OmniPro II controller to each PESH. Connect as shown in **FIGURE 12 (PESH CONNECTIONS)**.
4. The PESH should be mounted on an interior wall, preferably close to the HVAC thermostat. Run a 2-conductor wire from the PESH to the thermostat. Connect the PESH between the RED wire going to the thermostat and the RED terminal on the thermostat.
5. Program the zone type for PESHs as a Type 80, Energy Saver. It may also be programmed as a Temperature (Type 82), or Temperature Alarm (Type 83) for special applications.

### NOTES ON HVAC SYSTEMS

1. Description of the PESH

The PESH is a temperature sensor and control relay in a small enclosure that mounts near a central heating, ventilation, and air conditioning (HVAC) system thermostat. The PESH allows the automation system to read the temperature of the area that the HVAC system controls. The relay in the PESH is used to break the 24V RED wire between the thermostat and the HVAC system. When the automation system is in setback mode and the actual temperature is between the LO and HI setpoints, the relay energizes to break the 24V red wire; hence, the HVAC system will no longer operate.

In heating season, when the actual temperature falls below the LOW setpoint, the automation system turns the relay in the PESH off, thus restoring power to the thermostat, allowing the thermostat to heat as it normally would under the control of the thermostat. The PESH will cycle the thermostat on and off to maintain the LOW setpoint.

In cooling season, when the actual temperature rises above the HI setpoint, the automation system turns the relay in the PESH off and the thermostat will cool as it normally would under the control of the thermostat. The PESH will cycle the thermostat on and off to maintain the HI setpoint.

The Red LED on the PESH will illuminate when the PESH is overriding the thermostat. The Red LED will be off when the thermostat is working normally.

If the PESH is disconnected from the automation system, the relay will not energize and the HVAC system will operate normally, under the control of the thermostat.

2. Standard Heating and Cooling Systems

The PESH is compatible with all mechanical thermostats. Recommended thermostats are simple, round Honeywell T-87 thermostats. For automatic switch-over from heat to cool, consider a Honeywell T-874 (mechanical) or an Enerstat DSL-300 (electronic) thermostat, although any other mechanical thermostat from White Rodgers, Robertshaw, etc. will work.

3. The PESH is also compatible with electronic thermostats that run totally on battery power. Some examples of battery powered thermostats are Maple Chase Saverstat (Mfg. #0960-1), White-Rodgers Digital Programmable Thermostat (Mfg. #1F80-51), and Honeywell Chronotherm Thermostat.

#### 4. Heat Pumps

Programmable Energy Saver Modules are compatible with heat pumps, however, the savings gained by setting the heat pump back may be erased by the auxiliary heaters when the heat pump tries to recover from the setback. A PESM will work best with heat pumps that have one or more of the following features:

- a. An outdoor temperature switch that prevents the auxiliary heat from coming on unless it is very cold outside. This is sometimes called a "heat balance" switch.
- b. A thermostat that uses rate of rise to determine if auxiliary heat is necessary: The Enerstat Model DSL-450. When recovering from setback, the thermostat runs the heat pump first. It will run the auxiliary heat only if the rate of temperature rise is less than 6 degrees F. per hour.
- c. An alternative auxiliary heat source that is inexpensive (i.e. gas).

These features will avoid the use of auxiliary heat (usually an electric strip heater) which is more expensive than using the heat pump when recovering from setback. In general, heat pumps take a longer time to recover from setback, so it may be advantageous to program a setback only for extended periods, such as a vacation.

### TEMPERATURE, OUTDOOR TEMPERATURE, AND HUMIDITY

When connected to the controller, the Model 31A00-1 Indoor/Outdoor Temperature and Model 31A00-2 Indoor/Outdoor Temperature and Humidity Sensor is used for sensing indoor temperature and/or reporting the relative humidity from 0 to 100 percent or for sensing the outdoor temperature and/or reporting the outdoor relative humidity. The outdoor temperature can be displayed on the console, spoken over the telephone, or displayed on an HAI Communicating Thermostat.

1. Each Temperature Sensor requires one zone input. Each Humidity Sensor requires one zone input.
  - Program the zone type as an Outdoor Temperature (Type 81), Temperature (Type 82), Temperature Alarm (Type 83), or Humidity (Type 84).
2. When mounting outdoors, plan to mount under an overhang or to the underside of an eave, otherwise known as the soffit, to protect it from direct sunlight and rain. Run a 4-conductor wire from the OmniPro II controller to the selected location.

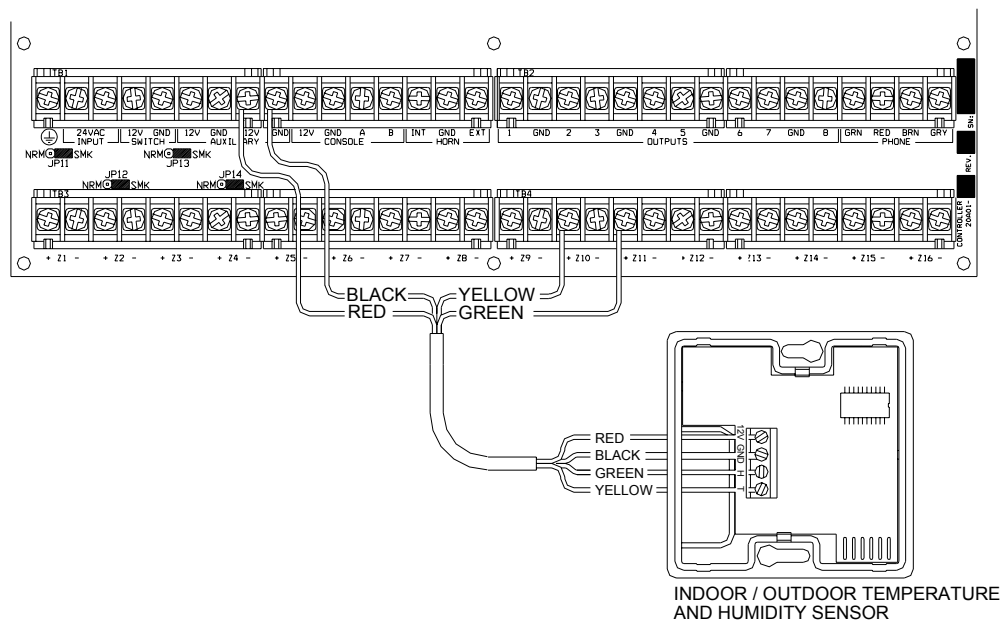

**FIGURE 11 - TEMPERATURE / HUMIDITY SENSOR CONNECTIONS**

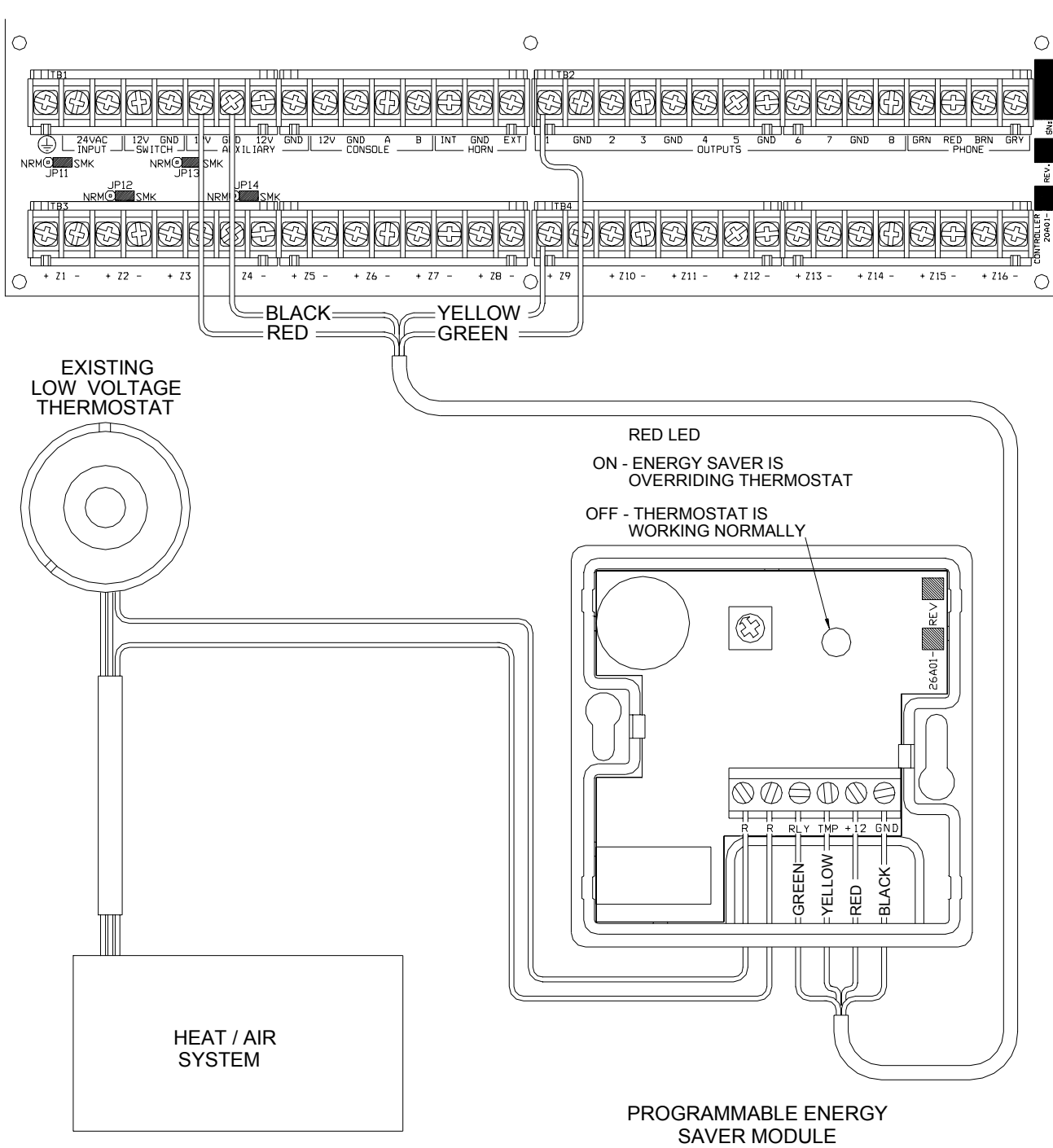

**FIGURE 12 - PESM CONNECTIONS**

## BUILT-IN SERIAL PORTS

OmniPro II has 3 serial ports (J1-J3) built onto the controller (labeled SERIAL 1 - SERIAL 3, respectively). The interface is a modular connector located in the upper left corner of the controller. It uses either the Omni-Link or Pro-Link Protocol for connections to the Internet via HAI Web-Link II, personal computers, and other optional interfaces like touchscreens, voice recognition, lighting controls, and home theater controls.

Each serial interface supports both RS-232 and RS-485 connections. RS-232 is the standard for connections to most personal computers and related systems. RS-485 can support greater wiring distances. The default setting is RS-232. To select RS-485, move the interface jumper (JP1-JP3) from the 232 to the 485 position. The jumpers (JP1-JP3) are located below the modular serial port connectors (J1-J3).

To access a serial port, use the HAI Model 21A05-2 Serial Cable Kit. Plug one end of the cable into one of the modular serial port connectors on the controller. Plug the other end into the Model 21A05-1 Communication Cable Adaptor (modular to DB-9 RS-232), which connects the OmniPro II serial port to the computer's DB-9 RS-232 port.

To make your own serial cable, follow the diagrams (Figure 13 and Figure 14). When making connections, be sure to correctly orient the cable as shown (with the tab on the modular cable facing up, make sure that the Yellow wire is at the top). Connect the Yellow, Green, Red, and Black wires to the DB-9 connector as shown. Also, connect Pins 1, 4, and 6 together and Pins 7 and 8 together.

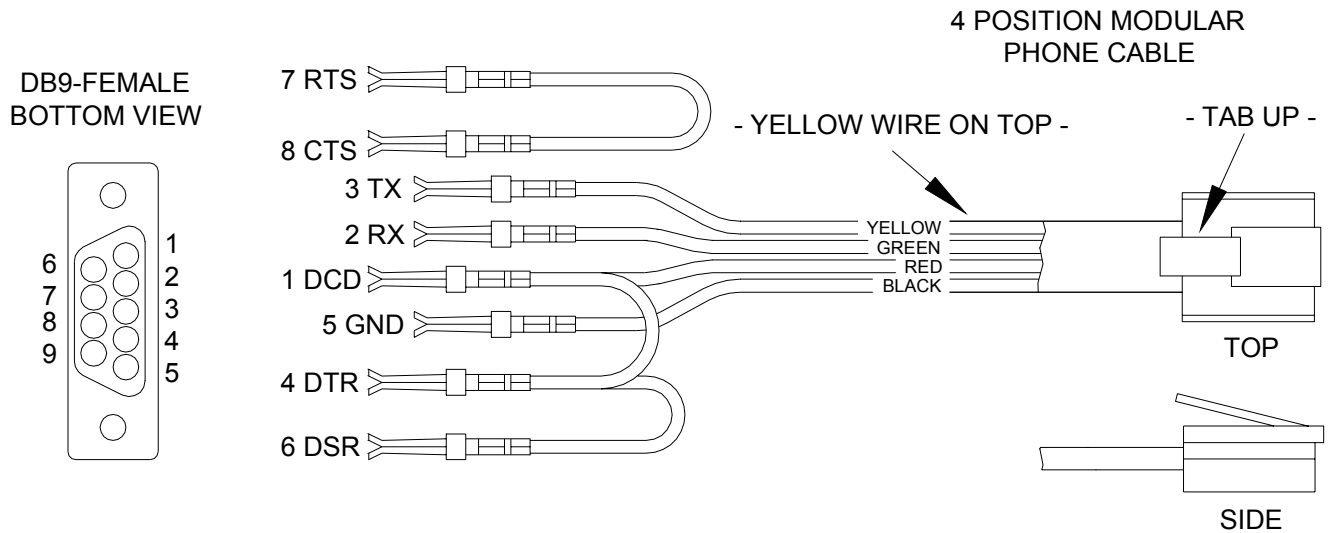

**FIGURE 13 - RS-232 CONNECTIONS**

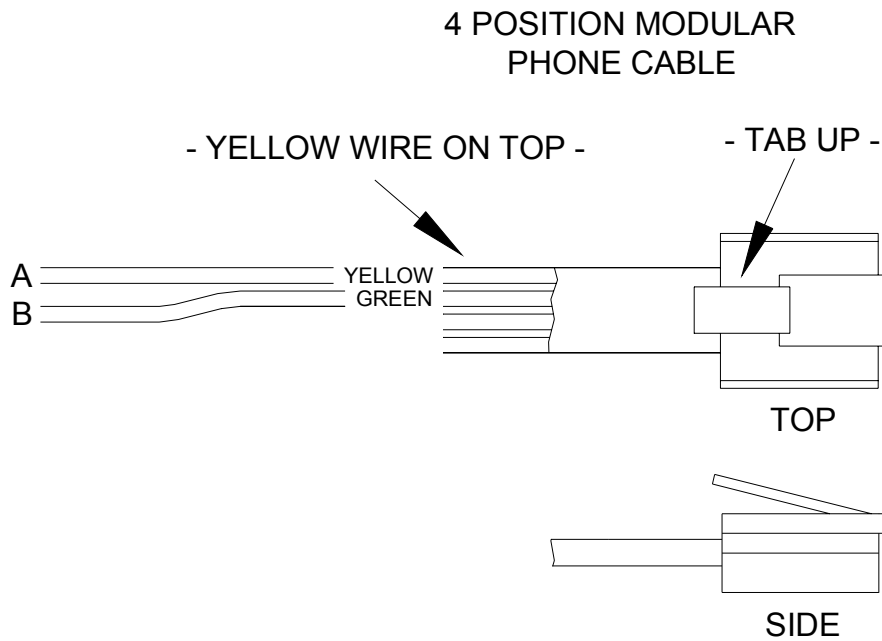

**FIGURE 14 - RS-485 CONNECTIONS**

### **BUILT-IN ETHERNET PORT**

OmniPro II has an Ethernet port (J6) built onto the controller (labeled ETHERNET). The Ethernet port allows a device to connect to the OmniPro II controller via a network (i.e. Ethernet, Internet) using a secure, encrypted communication link. The Ethernet port transports HAI application-level packets containing Omni-Link serial protocol messages over IP. The controller supports 3 unique client “sessions” which means 3 devices may actively be connected and communicating with the controller simultaneously over the Ethernet port.

### **CONTROLLER IP ADDRESS, PORT NUMBER, AND ENCRYPTION KEY**

The controller’s local IP address and port number set the local network parameters for the OmniPro II controller. The encryption key is used to establish a private, secure connection with the connected device.

The following Setup items can only be assigned and changed from an HAI console. These items can not be assigned or changed via PC Access; although the IP address and port number may be viewed via PC Access:

## CONTROLLER IP ADDRESS

The controller's local network IP address is used to identify the OmniPro II controller on the network. To view and assign the controller's local network IP address, from the Set Up menu, press the 6 (MISC) key. Using the down arrow key (↓), scroll to the following menu item:

```
IP ADDRESS
192.168.0.101      ↓
```

The format of the IP address is a 32-bit numeric address written as four numbers separated by periods. An IP address has two components, the network address, and the host address. The first two numbers (e.g. 192.168) represent the Class B network address and must be the same as the first two numbers of your local network. The second two numbers (e.g. 0.101) identify a particular host on the local network and may be assigned at random as long as each device on the local network has a unique address. Each number can be 0 to 255. Enter the 1, 2, or 3 digit number followed by the “#” key to move to the next number. After the 4<sup>th</sup> number has been entered, press the “#” key to store the IP address.

## CONTROLLER PORT NUMBER

The controller's local network port number identifies the logical channel to the OmniPro II controller. For example, port 80 is used for HTTP traffic; the controller's local network port number is used for Omni-Link traffic. To view and assign the controller's local network port number, from the previous Setup item (IP ADDRESS), press the down arrow key (↓).

```
PORT NUMBER      4369
0-65535          ↓
```

In most installations, the default port number can remain the same. Port numbers range from 0 to 65535. To change the port number, enter the new port number followed by the “#” key to store the port number. Port numbers 0 to 1024 are reserved for designated services and should not be used.

## ENCRYPTION KEY

Encryption and decryption of data between the OmniPro II controller and the connected device is based on the Advanced Encryption Standard (AES) using a 128-bit cryptographic key. A unique encryption key is randomly assigned to each OmniPro II controller at the factory (no records of these keys are kept at the factory). It may be left the same (recommended) or it may be changed as desired. To view and assign the encryption key, from the previous Setup item (PORT NUMBER), press the down arrow key (↓).

```
ENCRYPTION KEY PT 1:
6F-1B-26-A2-FF-D9-E4-12↓
```

This key consists of 16 bytes (that is 16 2-digit values from 0-9 and/or the letters A-F). It is entered into the controller in two parts (PT 1 and PT 2) consisting of 8 bytes each. Enter the 2 digit value. To enter the digits A-F, first press the “OFF” key, then press the 0-5 key respectively (i.e. A1 = OFF 0 1 and CB = OFF 2 OFF 1). After the last digit (16<sup>th</sup> digit) has been entered, press the “#” key to store “PT 1” of the encryption key. Press the down arrow key (↓) to enter “PT 2” of the encryption key.

```
ENCRYPTION KEY PT 2:
DC-67-48-8F-D1-3A-EF-70↑
```

After the last digit (16<sup>th</sup> digit) has been entered, press the “#” key to store “PT 2” of the encryption key.

## OMNIPRO II ETHERNET CONNECTIONS

Use a standard network cable to connect the controller to a hub, switch, or router. Use a network crossover cable when connecting the controller directly to the NIC card on a computer.

When connected to a switch or router, port forwarding must be configured. Port forwarding sets up public services on your network. The OmniPro II controller listens for all IP/UDP communications addressed to it on the specified UDP port number. The router will forward all communications on the specified port to the OmniPro II controller.

## CONNECTING TO NETWORK VIA PC ACCESS

To access the controller over the network via PC Access:

1. Open an OmniPro II account file.
2. Click *Configure >> Network*.
  - If you are connecting from the local network, enter the controller's IP address under "Network IP Address or Domain Name".
  - If you are connecting from the Internet, enter either the public IP address (the way to reach your local network via the Internet) or domain name (e.g. www.homeauto.com).
3. Enter the port number that is configured for the controller.
4. Select the *Encryption* tab. Enter the two part encryption key as it is displayed on the console.
5. Select *OK*.
6. Click *Connect >> Network >> Connect*. PC Access should change from "Off-Line" to "On-Line".

The "Modem" item on the main menu has been replaced with the "Connect" item. The submenu under "Connect" then allows selection of "Modem", "Serial" or "Network". When an account file is opened, the connection type will default to "Serial".

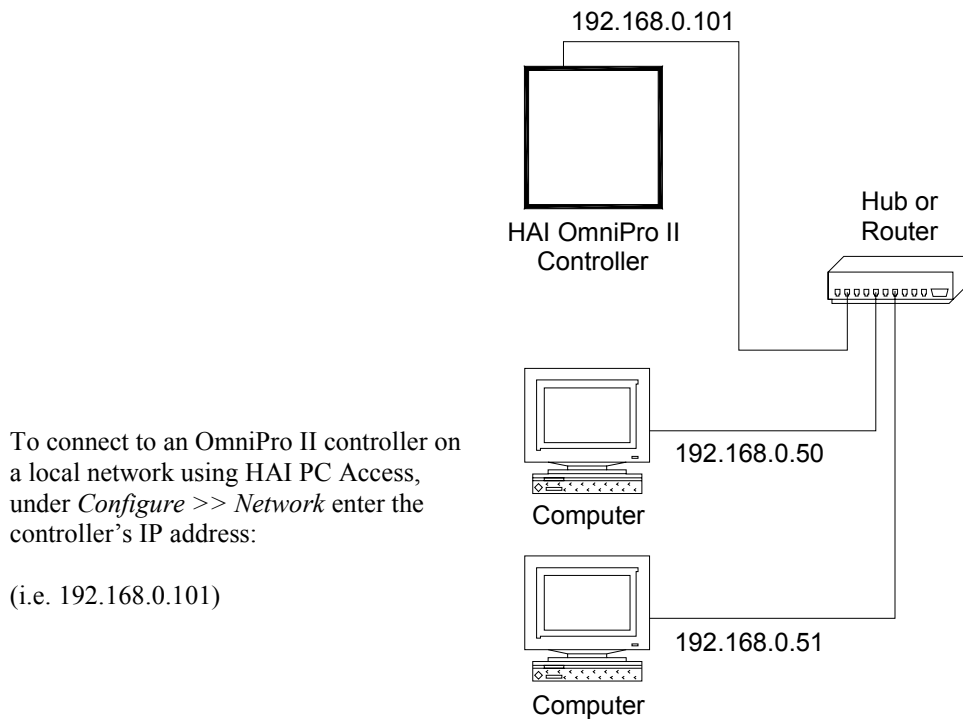

**FIGURE 15 - LOCAL NETWORK**



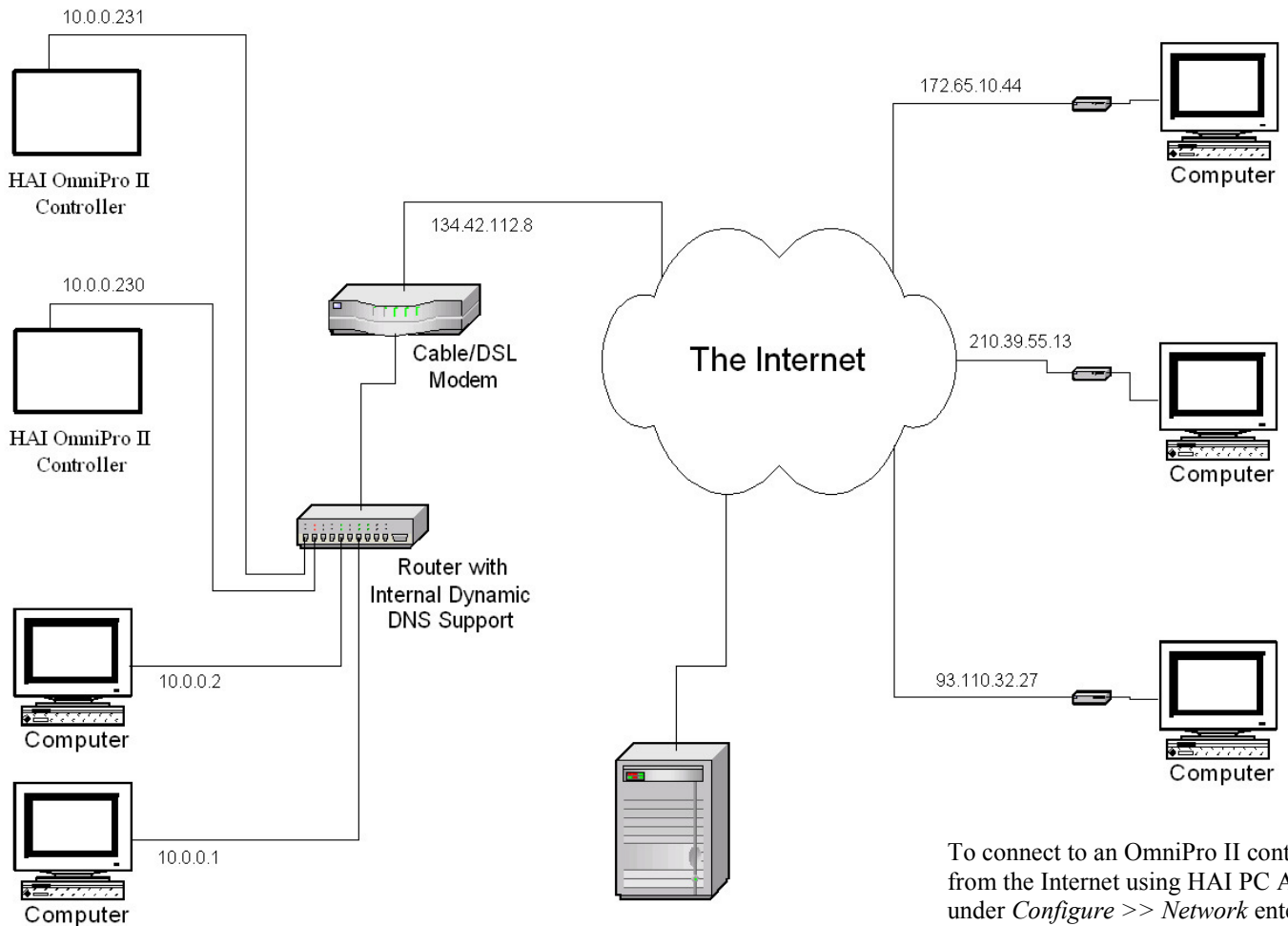

To connect to an OmniPro II controller on a local network using HAI PC Access, under *Configure >> Network* enter the controller's IP address:

(i.e. 10.0.0.230)

To connect to an OmniPro II controller from the Internet using HAI PC Access, under *Configure >> Network* enter the public IP address:

(i.e. 134.42.112.8)

## FIGURE 16 - LOCAL / WIDE AREA NETWORK

If the controller is connected to the Internet via a dynamic IP address, to locate and communicate with the controller from remote locations over the Internet using HAI PC Access, you must subscribe to a Dynamic DNS (Domain Name Service). Dynamic DNS is a service that maps your dynamic (changing) IP address to a static (permanent) hostname, allowing you to access your OmniPro II controller over the Internet using your static hostname instead of an IP address.

A "client" program (typically provided by the Dynamic DNS provider) runs on a PC on your local network and is used to automatically update your Dynamic DNS provider with your current IP address. Several router/switch manufacturers have embedded a Dynamic DNS client into their router firmware. These devices work with several of the Dynamic DNS providers, including both free and commercial services. These devices are especially beneficial because the router can be powered up all the time, so the dynamic update is always current and is handled by a single device (the router/switch) in the local network. This allows you to locate and connect to the OmniPro II controller without having a computer on the local network powered up and running.

## **SYSTEM POWER UP PROCEDURE**

1. Carefully review hookups to the zones, grounds, sounders, and consoles.
2. Disconnect 1 lead of both the interior and exterior sounders.

NOTE: Follow this power up procedure to verify proper operation of the power supply, battery charger, and low voltage cut out relay.

3. The positive lead to the battery should be disconnected at this time. Make sure that the red battery wire is not touching anything.
4. Plug in the power transformer.
  - The AC ON LED should illuminate.
  - Within one minute, the STATUS LED should begin blinking at a rate of 1 blink per second. This indicates that the OmniPro II processor and software are working.
  - The PHONE LED should be OFF (if all telephones are on-hook and the RJ31X jack is properly connected).
5. Unplug the power transformer to kill the system. Connect the red battery wire to the + (positive) battery terminal. The system should not start.
6. Plug in the power transformer. The system should start.
7. Unplug the power transformer. The system should continue to run on the battery (the STATUS LED will continue to flash).
8. Plug the transformer back in and secure it to the outlet.

## **CONSOLE CHECK OUT**

1. The console(s) should be operating. Press '\*' to silence the trouble beeper if it is beeping. Press OFF, 1, 1, 1, 1 (or the current User code) if the alarm is tripped. If the consoles are not operating properly, make sure that no two consoles have the same address, and check the wiring.
2. With all doors and windows closed and all motion detectors secure, the bottom line of the display should read SYSTEM OK. If there are any trouble indications that occurred during installation, press '\*' to acknowledge them and silence the beeper.
3. Set the time and date by pressing the 9 key. Enter the Master Code, then press the 2 key. Enter the time on the keypad, then the DATE (enter date as 6 characters: January 1, 02 as 010102).
4. The console should now show the time and date on the top line and "SYSTEM OK" on the bottom line.

## **TELEPHONE CHECK OUT**

1. Verify that the Telephone Company surge arrestor is properly grounded.
2. Verify that the incoming telephone lines are run to the surge arrestor first, then from the surge arrestor to the RJ31X jack, then from the RJ31X jack to the house phones.
3. The PHONE LED, on the controller, should be off when the phones are hung up.
4. Pick up an in-house phone, wait about 1 second, then press the '#' key. You should hear the Voice menu on the phone. If not, check to see that the RJ31X jack is properly wired and connected to the controller. There should be no interference from the Telephone Company while the menu is being read over the phone.

5. Record the owner's NAME and ADDRESS in the ADDRESS speech memory as shown in SETUP ADDRESS in the OWNER'S MANUAL (Press 8, 9, then 1111 or the current Master code to record the address).

NOTE: DO NOT record any TOUCH TONES in the ADDRESS!!

6. Check that all in-house phones are working.

## **BURGLAR ZONE CHECK OUT**

1. With all doors and windows closed and all motion detectors and security devices secure, the console display should read "SYSTEM OK".
2. If any zones are abnormal, check your wiring. If the battery indication is low, make sure that the battery is connected securely. Give the battery a chance to charge.
3. From the top-level display, have a partner go around the house and trip each sensor one at a time. The display should indicate the correct zone "NOT RDY" when the zone is tripped, then return to "SYSTEM OK" when the zone is secured. Be sure that the zone type indicated (ENTRY/EXIT, PERIMETER, ETC.) is correct for the zone being tested.
4. If the zone being checked is armed, (i.e. PANIC or TAMPER type, which is always armed) the alarm will be activated. Press OFF and 1111 or the current User code to silence the alarm, or bypass the PANIC and TAMPER zone(s) before you start.
5. Reconnect the sirens. Be sure that no one is standing near a siren. Activate the alarm, and ensure that both the inside and, after a delay, outside sirens activate.

## **FIRE ZONE CHECK OUT**

1. Press ' \* ' to return the console to the SYSTEM OK indication. Check the fire zone per the sensor manufacturer's instructions. The fire alarm should be activated (pulsing interior sounder, exterior siren).
2. Press ' \* ' to silence the alarm. The display will still indicate that the FIRE ZONE is in alarm.
3. Press DAY or NIGHT or AWAY and the User code to arm the system, then OFF and the User code to disarm. This arm/disarm cycle will reset the smoke detector. If the cause for alarm (i.e. smoke) has cleared, the display will return to SYSTEM OK.

NOTE: Be sure that the DIAL OUT DELAY is long enough so that you can cancel the alarm before the system dials out.

## **HOME CONTROL CHECKOUT**

1. Confirm that the HOUSE CODE on the OmniPro II is set to the same HOUSE CODE set on all of the modules (See SETUP CONTROL).
2. On the console press 4, 1 (ALL ON). All lamp type modules should go on. Note that some modules, such as appliance modules, voltage outputs, and flags do not respond to ALL ON.
3. On the console press 4, 2 (ALL OFF). All modules should go off. Note that voltage outputs and flags do not respond to ALL OFF.
4. Operate each unit number individually and verify that it works.
5. Ensure that all inputs and outputs are working.

## **CUSTOMER CHECKOUT**

After you have completed the system check out and everything works, be sure that the customer knows how to:

1. Disarm/silence the system (OFF, 1111 or current User code). **HAVE THE CUSTOMER PRACTICE!**
2. Change the codes.
3. Get the menu over the in-house phones.

### **You should also:**

4. Demonstrate arming and disarming.
5. Demonstrate home control.
6. Demonstrate setup and programming.
7. Show him/her how to program the dial out numbers.
8. Deliver the Owner's Manual.
9. If the customer has subscribed to a central monitoring service, this should be explained to him/her.

## **IN CASE OF TROUBLE**

### **CONSOLES**

If you experience trouble that seems to be with a console, try disconnecting the console and running the console self test as described under CONSOLE HOOKUPS in this manual. If the console does not run the self-test properly, it should be returned to HAI for repair.

"NO CONTROLLER DATA" or erratic operation of the LCD display could be a result of: A and B terminals connected backwards, poorly, or 2 or more consoles have the same address.

### **CONTROLLER**

Check the AC ON (bottom) LED. If it is not lit, check for 24 VAC at the transformer connections.

Check the STATUS (top) LED on the controller board. It should be blinking once per second, indicating the proper operation of the microprocessor and memory. If not, try powering the system down by disconnect the power transformer and battery, then reconnect both. The status light should begin blinking.

If the AC ON LED is on and the STATUS light is still not blinking, check the AUX +12 V with a DC voltmeter. It should be 13.7 volts. If not, make sure that there isn't too much load on the system. Disconnect all loads. If the STATUS LED still won't blink, there is a problem with the controller board and it must be returned to HAI for repair.

Phone line problems, or problems with the OmniPro II voice are usually the result of the RJ31X jack being improperly wired. Check RJ31X jack wiring and polarity carefully, as described in TELEPHONE CONNECTIONS.

In the event that the controller is found defective, the controller board can be removed without disconnecting the entire wiring from their terminals. The terminal strips can be removed from the controller board. Then the controller (or processor board) can be repaired and reinstalled easily.

**Follow this procedure for removing the controller board:**

1. If possible, upload the programs and configuration. (This will not be possible if the status LED isn't flashing or if you can't get the voice to work.)
2. Unplug the power transformer.
3. Disconnect the battery
4. Disconnect the RJ31X modular cable at the jack!! If you only disconnect it at the OmniPro II controller only, the house phones won't work.
5. Disconnect the X-10 cable. Disconnect the serial cable(s). Disconnect Ethernet cable.
6. Carefully remove the four terminal strips from the controller board. Gently push down on terminal strip retention clips. These clips are located on either end of the strip and 2 in the middle. Slowly pull strip away from terminal block socket and secure.
7. Remove 9 screws and washers; 3 on the top edge, 3 on the bottom edge, and 3 in the middle of the controller.
8. Remove the controller board.
9. Wrap the controller board with protective material and pack carefully. HAI will not be responsible for returned items damaged due to inadequate packaging.
10. Call Home Automation, Inc. with the serial number for a Return Authorization number to help us track your return. Write the R. A. # on the outside of the package.
11. Return the controller to Home Automation, Inc. Please include your return address, any special shipping instructions and daytime phone number so that we can reach you if we have any questions. Also include a brief description of the problem that you are having.
12. INSTALLATION: follow the removal process in reverse. Follow the POWER UP and CHECK OUT procedures in this manual.
13. NOTE: When a controller is returned from being repaired, all setup and programming is lost. The board is returned with the factory default setup and programming.

FOR HELP: Call HAI between the hours of 9:00 AM and 5:00 PM Central time, Monday - Friday, at (800) 229-7256.

## **DIGITAL COMMUNICATOR**

The OmniPro II digital communicator can use Contact ID, or Standard 4/2 or 3/1, (20 pps, 1800 Hz data, 2300 Hz handshake), or (10 pps, 1900 Hz data, 1400 Hz handshake), dual round compared format. Any central station with modern equipment can receive these formats. Compatible receivers are Ademco, Radionics, Osborne-Hoffman, Linear, FBI, and Silent Knight. It is up to the installer to verify compatibility. At the time of installation, the installer is required to verify compatibility and phone line seizure of the Digital Communicator.

If the digital dialer does not get a handshake signal from the central station 45 seconds after it begins dialing, it hangs up and tries again. The dialer will try the FIRST PHONE NUMBER 5 times, then go to the SECOND PHONE NUMBER and try that 5 times. After that, the system will indicate COMMUNICATIONS FAILURE on the console display and the digital communicator will not try again until another reportable event occurs.

The digital communicator will not dial out until the DIAL OUT DELAY has expired. If the alarm is canceled prior to the expiration of the DIAL OUT DELAY, no transmission will take place. After the DIAL OUT DELAY has expired, though, all alarm trips will be transmitted followed by a CANCEL code.

When the digital communicator is used, all voice dial outs will be delayed for five minutes after the expiration of the dial out delay to allow time for the central station to call the premises after an alarm code has been sent. If the digital communicator is unable to successfully communicate with the central station, the user will be alerted to the trouble condition. When the system status is requested using the voice, this condition is reported over the phone as "SECURITY PHONE MESSAGE" trouble.

### **DESCRIPTION OF CONTACT ID**

Contact ID reporting allows very specific event codes to be sent to the central station. A complete report takes under three seconds. Contact ID reporting uses predefined event codes that allow the central station to quickly identify the condition being reported. The specific security zone or user code is identified as part of the report.

For each event code transmitted, the report also includes an event qualifier that identifies whether the report is for a new event (such as a security zone trip), or a restoration of an event (such as a security zone no longer tripped). Trouble conditions are reported, as well as restoration of these trouble conditions. For security armings and disarmings, this event qualifier is also used to identify whether the report is for an arm or disarm. The reporting format for Contact ID is listed in Appendix A in this manual.

When using Contact ID, the alarm codes and/or reporting format cannot be changed. All alarm trips, regardless of Zone Type (except Auxiliary Inputs), will be reported to the Central Station.

### **DESCRIPTION OF 4/2 FORMAT**

The 4/2 format consists of a four-digit account code, from 0000 to FFFF and a two-digit alarm code from 00 to FF. When the digital communicator calls the central station receiver, the latter answers and sends a brief 2300 Hz tone or a 1400 Hz tone called a "Handshake" tone. The digital communicator then reports digits of the account and alarm codes as bursts of either (1800 Hz) or (1900 Hz) tone; the digit 8 is represented by eight bursts of tone. A message, or "round" consists of an account code and an alarm code. Two rounds are sent, and two consecutive rounds must match at the receiver. If they do, the central station receiver sends another brief 2300 Hz or 1400 Hz tone to acknowledge to the digital dialer that the message has been properly received. If the rounds don't match, the receiver does not send the second tone and the digital dialer tries again, up to 5 times. If the rounds are not acknowledged after 5 tries, the digital dialer hangs up and tries the entire call again.

The digital communicator can report alarm zone trips, alarm cancels, low battery, and fire zone trouble. It may also be setup to generate an automatic test signal at periodic intervals. The communicator may be setup to call second phone number using a second account number in the event that it is unable to communicate successfully using the first phone number and account.

The digital communicator is setup at the factory to transmit a code when the battery is low or trouble with the fire zone is detected. If these codes are set to 0 or 00, no code will be sent when the trouble condition is detected.

Although the alarm codes can be changed, we recommend that the alarm codes setup at the factory be used to minimize the risk of installer error in programming the digital communicator. Simply enter the phone numbers and account codes, then verify the alarm codes.

## **3/1 FORMAT**

Older central stations may require a 3/1 format. To use 3/1 format, both account numbers must be changed to 3 digit codes and EVERY alarm code must be changed to a 1-digit code. Do not mix code lengths!

## **OPENING AND CLOSING REPORTS**

The OmniPro II system can send opening and closing reports by user to the central station.

When the system is disarmed by user code 1-16, the communicator can call the central station and report that the system was disarmed (opened) with the user code that was used.

When the system is armed by user code 1-16, the communicator can call the central station and report that the system was armed (closed) with the user code that was used.

If any other code or a method disarms the system (i.e. Code 17-99, Keyswitch, or Scheduled Program), the communicator will send a generic OPEN report to the central station. The code that is sent is defined as OTHER OPEN. If the system is armed by any other method other than one that requires a code (i.e. Quick Arm, Keyswitch, or Scheduled Program), the communicator will send a generic CLOSE report to the central station. The code that is sent is defined as OTHER CLOSE.

## INSTALLER SETUP

This section describes the items that the installer must setup as part of system installation. The Installer Setup mode is used to configure the general operation of the system, the Outputs, the Areas, the Zone Types, the Digital Communicator, and various other settings. This information is covered only in this manual. All other SETUP items, including delay times, names and voices, voice dialer, and codes are covered in the Owner's Manual, Document No. 20R00-2.

SETUP items are stored permanently in the system, even if the battery and AC power are disconnected. The "default" settings are the ones that have been set at the factory. You can review or change the setup items easily, as shown below.

**Note:** The default Installer Code is 1111.

To access the SETUP menu, press the 9 key and enter the installer code. To access the INSTALLER SETUP menu, press the # (INST) key.

```
INSTALLER SETUP MENU :  
1=CTRL  2=ZONE  3=DCM  ↓  
  
4=AREA  5=TEMP  6=MISC  
7=EXP   ↑
```

## SETUP CONTROL

To configure X-10 and voltage outputs, from the Installer Setup menu, select the 1 (CTRL) key.

The base X-10 house code must be specified, as well as the output type for each of the 8 voltage outputs. The output type for both the interior and exterior horns may also be changed.

Press (↓) to advance to the next item, (↑) to go back.

### X-10 HOUSE CODE

The base house code is the house code for units 1-16 and is referenced as house code 1. The house code for the units 17-32 is the next house code after the base house code, or house code "B" if the base house code is "A".

```
X-10 HOUSE CODE :      A  
1-16=A-P              ↓
```

### X-10 3-PHASE

This setting is used to select whether the X-10 signal is transmitted only at zero crossing for single phase (120V/240V) electrical systems or is transmitted at 0, 60, and 120 degrees for three phase electrical systems.

```
X-10 3-PHASE :        0  
0=NO 1=YES           ↓
```

To turn 3-Phase On, press 1 then '#'. To turn 3-Phase Off, press 0 then '#'. The burst at 60 and 120 degrees will be eliminated.

The default setting for 3-Phase is No.



## OUTPUT TYPES

An output type must be specified for each of the voltage outputs and for the interior and exterior horn outputs.

The first group of outputs is global. This means that the output is valid for any area. The sounder and communicator outputs will be activated for an alarm in any area. The remaining types are area specific. This means that the output is only valid in the specified area. Area specific sounder and communicator types will only be activated for alarms in that area.

The following output types are available:

OUTPUT TYPE	NUMBER									DESCRIPTION
	Global	A1	A2	A3	A4	A5	A6	A7	A8	
GENERAL PURPOSE	0	0	0	0	0	0	0	0	0	General Purpose Output
OK TO ARM	1	17	33	49	65	81	97	113	129	OK To Arm Output
ARMED	2	18	34	50	66	82	98	114	130	Armed Output
PRE-ALM SNDR	3	19	35	51	67	83	99	115	131	Pre-Alarm Sounder
INT SNDR	4	20	36	52	68	84	100	116	132	Interior Sounder
INT BURG SNDR	5	21	37	53	69	85	101	117	133	Interior Burglary Sounder
INT FIRE SNDR	6	22	38	54	70	86	102	118	134	Interior Fire Sounder
EXT SNDR	7	23	39	55	71	87	103	119	135	Exterior Sounder
EXT BURG SNDR	8	24	40	56	72	88	104	120	136	Exterior Burglary Sounder
EXT FIRE SNDR	9	25	41	57	73	89	105	121	137	Exterior Fire Sounder
BURG COMM	10	26	42	58	74	90	106	122	138	Burglary Communicator
FIRE COMM	11	27	43	59	75	91	107	123	139	Fire Communicator
AUX COMM	12	28	44	60	76	92	108	124	140	Auxiliary Communicator
SWITCHED POWER	13	29	45	61	77	93	109	125	141	Switched Power Output

The Setup Control items are:

```

OUTPUT 1 TYPE:          0
GENERAL PURPOSE #=CHNG ↓

OUTPUT 2 TYPE:          0
GENERAL PURPOSE #=CHNG ↓

OUTPUT 3 TYPE:          0
GENERAL PURPOSE #=CHNG ↓

OUTPUT 4 TYPE:          0
GENERAL PURPOSE #=CHNG ↓

OUTPUT 5 TYPE:          0
GENERAL PURPOSE #=CHNG ↓

OUTPUT 6 TYPE:          0
GENERAL PURPOSE #=CHNG ↓

OUTPUT 7 TYPE:          0
GENERAL PURPOSE #=CHNG ↓

OUTPUT 8 TYPE:          0
GENERAL PURPOSE #=CHNG ↓

INTERIOR HORN:          4
INT SNDR                #=CHNG ↓

EXTERIOR HORN:          7
EXT SNDR                #=CHNG ↑
    
```

For output types, the current setting is shown on the bottom line. Press the '#' key to select a new type from a list of types. The display shows:

```
SELECT TYPE :          6
INT SNDR      ↓
```

Use the Up and Down arrow keys to scroll through the list, or select the appropriate output type number. Then press '#' to enter the new type.

If the Interior Horn is configured as a "General Purpose" output, Unit Number 393 is used to control the output. If the Exterior Horn is configured as a "General Purpose" output, Unit Number 394 is used to control the output. In this configuration, Unit Numbers 393 and 394 should not be used as "Flags".

## SETUP ZONES

To configure zone expansion and the zone type for each security zone, from the Installer Setup menu, select the 2 (ZONE) key.

### ZONE EXPANSION

Expansion Enclosures can be used to add additional zones to the OmniPro II system. Each Expansion Enclosure adds 16 zones to the system. If used, you must specify the number of Expansion Enclosures (1-8) used.

Each Model 17A00 Expansion Enclosure adds 16 hardwired zones to the OmniPro II system.

Wireless Receives can also be used to add additional zones to the OmniPro II system. When connected to an OmniPro II, the Wireless Receiver is recognized as an Expansion Enclosure. Each Wireless Receiver can handle up to 64 wireless zones, in groups of 16. Each group of 16 zones is considered 1 Expansion Enclosure. You must specify how many groups of wireless zones are being used.

Specify the number of 17A00 Expansion Enclosures plus the number of wireless groups:

```
NUMBER OF EXP ENCL    0
1 - 8                  ↓
```

### NOTES:

1. Up to 2 Model 10A06 Hardwire Expanders can be used with OmniPro II. Zones 1-16 on the first Expander are Zones 17-32 on OmniPro II. Zones 1-16 on the second Expander are Zones 33-48 on OmniPro II.
2. When used, the Model 10A06 Hardwire Expander Modules must be configured under Setup | Installer | Expansion.
3. Zones 1-16 on the first Expansion Enclosure are Zones 49-64 on OmniPro II. Zones 1-16 on the 2nd - 8th Expansion Enclosure are Zones 65 -176, respectively on OmniPro II.

### ZONE RESISTORS

This item is used to specify if the 1000-ohm end-of-line zone resistors will be used with zone inputs on the controller and zone expanders (this does not affect Expansion Enclosures). If this item is set to "Yes", all zones are required to use an end-of-line resistor.

End-of-line zone resistors are always required on Supervised Fire and Gas zones, and all zone inputs on Expansion Enclosures.

The default setting is "Yes".

```
ZONE RESISTORS :      1
0=NO 1=YES           ↓
```

## Z 1 TYPE THROUGH Z176 TYPE

This item specifies the zone type for each zone. All choices are listed in this manual under DESCRIPTION OF ZONE TYPES.

For zone types, the current setting is shown on the bottom line.

```
ZONE 1 TYPE:          64
AUXILIARY             #=CHNG ↓
```

THROUGH

```
ZONE 176 TYPE:       64
AUXILIARY             #=CHNG ↑
```

To change a zone type, press the '#' key, then use the arrow keys to scroll through the list of zone types. Press the '#' key to select a new type. The display shows:

```
SELECT TYPE:         1
PERIMETER             ↓
```

## ZONE RESPONSE TIME

All zones, in the OmniPro II are set to a 300 millisecond fixed response time.

## ZONE TYPES

ZONE TYPE	NUMBER	DESCRIPTION
ENTRY/EXIT	0	Entry/Exit
PERIMETER	1	Perimeter
NIGHT INT	2	Night Interior
AWAY INT	3	Away Interior
2X ENTRY DELAY	4	Double Entry Delay
4X ENTRY DELAY	5	Quadruple Entry Delay
LATCH PERIM	6	Latching Perimeter
LATCH NIGHT INT	7	Latching Night Interior
LATCH AWAY INT	8	Latching Away Interior
PANIC	16	Panic
POLICE EMERG	17	Police Emergency
SILENT DURESS	18	Duress
TAMPER	19	Tamper
LATCH TAMPER	20	Latching Tamper
FIRE	32	Fire
FIRE EMERG	33	Fire Emergency
GAS	34	Gas Alarm
AUX EMERG	48	Auxiliary Emergency
TROUBLE	49	Trouble
FREEZE	54	Freeze
WATER	55	Water
FIRE TAMPER	56	Fire Tamper
AUXILIARY	64	Auxiliary
KEY SWITCH	65	Keypad Input
ENERGY SAVER	80	Programmable Energy Saver Module
OUTDOOR TMP	81	Outdoor Temperature
TEMPERATURE	82	Temperature
TEMP ALARM	83	Temperature Alarm
HUMIDITY	84	Humidity

## **LATCHING ZONE TYPES**

When any device (other than FIRE or GAS) is connected to SWITCH 12V or a Switched Power Output, the zone must be configured as one of the LATCHING ZONE TYPES (latching perimeter, latching night interior, latching away interior, and latching tamper). LATCHING ZONE TYPES ignore the status of that zone during power cycles.

Used primarily when the FIRE ALARM VERIFICATION feature is being used or if more than one area is being protected. This type will ignore the status of LATCHING ZONES (i.e. Glassbreak Detectors) when the power is switched to reset devices.

## **DESCRIPTION OF ZONE TYPES**

### **ENTRY/EXIT**

ENTRY/EXIT ZONE types are intended for doors. ENTRY/EXIT ZONES are armed in security modes DAY, NIGHT, AWAY, and VACATION. In DAY and AWAY modes, there is an entry delay (defined by ENTRY DELAY) on ENTRY/EXIT ZONES to allow you to get into the house and turn off the alarm before it sounds. In NIGHT & DAY INSTANT mode, there is no entry delay, so that the alarm sounds immediately if someone opens a door.

There are two special types of ENTRY/EXIT ZONES for use with garage doors, or doors that are far away from the control console. They are called DOUBLE ENTRY DELAY and QUADRUPLE ENTRY DELAY zones. These zones have double or quadruple the ENTRY DELAY to give you additional time to reach the console to disarm the system upon returning. Only the ENTRY DELAY is extended on these zone types. The EXIT DELAY is not extended.

If an ENTRY/EXIT ZONE is tripped first, all other zones will be delayed.

### **PERIMETER and LATCHING PERIMETER**

PERIMETER ZONE types are intended for windows and exterior doors not requiring an entry delay. All PERIMETER ZONES are armed in security modes DAY, NIGHT, AWAY, and VACATION. There is not an entry delay on a perimeter zones. If a window or door on this zone is opened while the security system is in DAY, NIGHT, AWAY or VACATION mode, the alarm will sound immediately. LATCHING PERIMETER ZONES ignore the status of that zone during power cycles.

### **NIGHT INTERIOR and LATCHING NIGHT INTERIOR**

NIGHT INTERIOR ZONES are intended for motion detectors in areas where no one should be while you are sleeping in your home. For example, if you have a two-story home and sleep upstairs, your downstairs motion detector(s) should be on a NIGHT INTERIOR ZONE.

NIGHT INTERIOR ZONES are armed in security modes NIGHT, VACATION, and AWAY only. There is no delay on a NIGHT INTERIOR ZONE. Night interior zones are NOT armed in DAY or DAY INSTANT mode, so that you may move about freely in your home when the security system is in DAY or DAY INSTANT mode, while still having the windows and doors protected. LATCHING NIGHT INTERIOR ZONES ignore the status of that zone during power cycles.

### **AWAY INTERIOR and LATCHING AWAY INTERIOR**

AWAY INTERIOR ZONES are for areas of your home where no one should be while you are away. In the previous example, your upstairs motion detector(s) should be on an AWAY INTERIOR ZONE. AWAY INTERIOR ZONES are armed only when the security mode is AWAY. LATCHING AWAY INTERIOR ZONES ignore the status of that zone during power cycles.

### **PANIC, TAMPER, and LATCHING TAMPER**

PANIC and TAMPER ZONES are for emergency pushbuttons and tamper switches. PANIC and TAMPER ZONES are always armed, even if the security mode is OFF. There are no delays on PANIC and TAMPER ZONES. An emergency dial out is activated after the DIAL OUT DELAY.

TAMPER ZONES should be used for items such as gun cabinets and liquor closets.

LATCHING TAMPER ZONES ignore the status of that zone during power cycles.

### **POLICE EMERGENCY**

This zone type activates the burglar alarm and sounder. An emergency dial out is activated after the DIAL OUT DELAY.

### **DURESS EMERGENCY (SILENT DIAL OUT)**

If you wish to have a button in your home that activates a SILENT dial out, (no lights flashing and no sounder) it should be connected to a zone that is configured as a DURESS EMERGENCY. If this zone is accidentally tripped, you will not know that the OmniPro II is making a silent dial out, and hence won't know to stop it.

To stop a silent dial out once it has started, you must go to the console and press OFF then enter your code.

### **SUPERVISED FIRE**

Any zone can be programmed as a SUPERVISED FIRE ZONE. In UL Listed Installations, all fire detectors must be configured as a SUPERVISED FIRE ZONE and connected as shown in this manual. When Zones 1-4 are configured as a SUPERVISED FIRE ZONE, the corresponding Zone Jumpers (JP11-JP14) must be in the "SMK" (smoke) position.

### **FIRE EMERGENCY**

This zone type activates the fire alarm for a normally closed (open for alarm) and open collector (short to ground for alarm) switches. It is not supervised as required for UL Listed Installations and shall NOT be used in such installations.

### **GAS**

This GAS ZONE will generate an alarm, activate the sounder (on - off - on - long off), and make a dial out. This zone type requires an external 1000-ohm end-of-line resistor. When Zones 1-4 are configured as a GAS ZONE, the corresponding Zone Jumpers (JP11-JP14) must be in the "SMK" (smoke) position.

### **AUXILIARY EMERGENCY**

This AUXILIARY EMERGENCY ZONE type will generate an alarm (console beeper - no sirens) and make an emergency dial out when the zone is violated. An emergency dial out is activated after the DIAL OUT DELAY.

### **TROUBLE**

This zone type can be used to monitor the status of an external device, such as the battery status of a wireless security receiver. It can also be used to record events in the event log (i.e. driveway activation, opening of a gate, etc.) without setting off the alarm.

When the zone is tripped, the zone name will be displayed on the display as "NOT RDY". The alarm is not activated, regardless of the security mode. The trouble is logged in the event log. The digital communicator (if used) will report the alarm code for the zone. The voice dialer will not be activated.

### **FREEZE**

This FREEZE ALARM ZONE type will generate an alarm (console beeper, no sirens) and make an emergency dial out.

### **WATER**

This WATER ALARM ZONE type will generate an alarm (console beeper, no sirens) and make an emergency dial out.

## **FIRE TAMPER**

This zone type is used to monitor the wiring to bells and sirens (other than those connected to the Horn Output). The zone will report trouble if an open, short, or other wiring problem is detected in the supervised bell circuit. This zone will make a digital dial out when violated. Connect a wire from the Fire Tamper zone (+) to an output configured as a Sounder.

## **AUXILIARY**

A zone defined as AUXILIARY is ignored for security. It is used to activate macros or to conditionalize programs. This is the default setting for all zones. Zones that are not in use should be configured as AUXILIARY.

## **KEYSWITCH INPUT**

This zone is used to arm AWAY and Disarm the OmniPro II security system using a toggle (to ground) keyswitch or keypad.

## **PROGRAMMABLE ENERGY SAVER MODULE**

This zone type is for use with the Programmable Energy Saver Modules (PESM). It converts the Zone and the corresponding Output to operate the PESM. Only Zones 9-16 can be programmed as a PESM.

## **OUTDOOR TEMPERATURE**

Use this zone type for Outdoor Temperature Sensors. The outdoor temperature can be displayed on the console, spoken over the telephone, or displayed on an HAI Communicating Thermostat.

## **TEMPERATURE**

The general-purpose TEMPERATURE ZONE type is typically used to monitor indoor temperatures and control devices. It sets the zone secure/not ready state for program conditionals and event button activation programs.

If FREEZE ALARM is enabled, it reports a potential freeze condition if the temperature falls below 40°.

## **TEMPERATURE ALARM**

The TEMPERATURE ALARM ZONE type will generate an alarm (console beeper, no sirens) and dial out if the temperature goes above the high setpoint or drops below the low setpoint.

## **HUMIDITY**

The HUMIDITY ZONE type is used to monitor indoor and outdoor humidity levels from 0 to 100 percent using the Model 31A00-2 Indoor/Outdoor Temperature and Humidity Sensor. It sets the zone secure/not ready state for program conditionals and event button activation programs.

## **NOTE ON TEMPERATURE AND HUMIDITY ZONE TYPES**

Outdoor temperature, temperature, and temperature alarm zone types all have HEAT (LOW) and COOL (HIGH) setpoints. The zone is "Not Ready" when the temperature is above the high setpoint or below the low setpoint. The zone is "Secure" when the temperature is between the setpoints. Setting a setpoint to 0 disables the setpoint.

Except for a type 83, the alarm is not activated. The zone "Not Ready" or "Secure" status is used to activate button programs and program conditionals.

## SETUP DIGITAL COMMUNICATOR

To setup the Digital Communicator, from the Installer Setup menu, select the 3 (DCM) key.

### FIRST PHONE NUMBER, FIRST ACCOUNT NUMBER

The first item in the DIGITAL COMMUNICATOR category is the FIRST PHONE NUMBER. Enter the FIRST PHONE NUMBER on the keypad. This enables the Digital Communicator. You can cause a 2-second pause during dialing by pressing the DAY key. Press '#' when done.

```
FIRST PHONE NUMBER:
-                               ↓
```

To disable the digital communicator, enter a single "-" for the FIRST and SECOND PHONE NUMBER by pressing the OFF key, then '#'. Phone number may be up to 24 digits long.

Press the down arrow (↓) to advance to the FIRST ACCT NUMBER:

```
FIRST ACCT NUMBER:  0000
0-FFFF              ↓
```

Enter the 4 digit account number (3 digits if using 3/1 format) and press '#'. To enter the digits B-F, first press the OFF key, then press the 1-5 key respectively (i.e. 1B11 = 1 OFF 1 1 1 #).

NOTE: You must enter 4 digits for the account number if you are using 4/2 format (i.e. 0123), and 3 digits if using 3/1 (i.e. 123).

### SECOND PHONE NUMBER, SECOND ACCOUNT NUMBER

Enter these if used.

```
SECOND PHONE NUMBER:
-                               ↓
SECOND ACCT NUMBER:  0000
0-9999               ↓
```

### COMMUNICATOR TYPE

This item is used to select the transmitting parameters of the digital communicator. The OmniPro II can transmit in FAST 2300 Hz (20 PPS) mode, in SLOW 1400 Hz (10 PPS) 3/1 format, and in Contact ID.

```
COMMUNICATOR TYPE:    2
0=2300 1=1400 2=ID   ↓
```

The default setting is 2 = ID (Contact ID). If you need to transmit to a 4/2 or 3/1 receiver, select the proper handshaking frequency (2300 Hz or 1400 Hz) and press '#'.

### TWO-WAY AUDIO

If a Two-Way Audio Module is being used, this item enables hands free audio communication between your customer's premises and the central station. After the transmission of the alarm to the central station, the operator can talk and listen to people and sounds at the premises.

```
TWO-WAY AUDIO:       0
0=NO 1=YES           ↓
```

If a Two-Way Audio Module is part of the system, select the 1 (YES) key to enable this feature.

## REPORT OPEN/CLOSE

The communicator can be setup to send an opening and a closing report by user code. Whenever the system is disarmed the communicator will send an opening report to the central station. When the system is armed, the communicator will send a closing report to the central station.

```
REPORT OPEN/CLOSE:      0
0=NO 1=YES              ↓
```

To enable the communicator to send opening and closing reports to the central station, select the 1 (YES) key.

## AUTOMATIC TEST TIME

The communicator CAN be setup to automatically send a test code to the central station on a periodic basis. AUTOMATIC TEST TIME is used to set the time and days of the week of the test, and the TEST CODE specifies the code that will be transmitted for the test.

```
AUTOMATIC TEST TIME:
--      NEVER  #=CHNG↑
```

To disable the automatic test, press the '#' key and then 0 for Never, and '#'.

```
TEST CODE:              98
0-FF                    ↓
```

## ALARM CODES (4/2 and 3/1 Formats)

Press the down arrow (↓) to advance to the next ZONE ALARM CODE. Press the up arrow (↑) to go to the previous ZONE ALARM CODE. To change an alarm code, enter two digits for 4/2 format, or one digit when using 3/1 format, then press the '#' key.

Enter the 2 digit alarm code (1 digit if using 3/1 format) and press '#'. To enter the digits B-F, first press the OFF key, then press the 1-5 key respectively (i.e. B1 = OFF 1 1 # and CB = OFF 2 OFF 1 #).

The various alarm codes are sent when the indicated alarm zone is tripped. Each alarm code must be two digits long for 4/2 format (01-FF), 1 digit for 3/1 format (1-F).

To disable the digital communicator for a specific zone, set the alarm code to 0 or 00. The digital dialer will not report when this zone is tripped.

```
ZONE 1 ALARM CODE:     01
0-FF                   ↓
```

THROUGH

```
USER 16 CLOSE CODE:   76
0-FF                  ↑
```



## SETUP AREAS

To configure the system for multiple areas, from the Installer Setup menu, press the 4 (AREA) key. The number of areas must be specified. Also, consoles, zones, units, thermostats, and buttons must be assigned to areas. By default, the system is setup for one area.

The display prompts for the number of areas that will be used:

```
NUMBER OF AREAS :      1
1-8
```

If you choose 2-8, the Setup Areas menu is displayed:

```
SETUP AREAS
1=CTRL  2=ZONES  3=BTTN ↓
4=CONS  5=TEMP   8=MSG
                                     ↑
```

### SETUP AREAS: CONTROL

To assign control units to specific areas, from the Setup Areas menu, press the 1 (CTRL) key.

Units can be setup so that they can be activated from specific areas or from all areas.

Units for an entire X-10 House Code (groups of 16 unit numbers) can be assigned to specific areas. Units 257-384 (Expansion Enclosure voltage outputs) can be assigned to specific areas in groups of eight. Units 385-392 (controller voltage outputs) may be assigned individually to specified areas. Units 393-511 (flags) can be assigned to specific areas in groups of eight.

#### X-10 UNITS

```
UNITS 1-16 AREAS:
1 2 3 4 5 6 7 8 0=CLR ↓
```

```
UNITS 17-32 AREAS:
1 2 3 4 5 6 7 8 0=CLR ↓
```

```
UNITS 33-48 AREAS:
1 2 3 4 5 6 7 8 0=CLR ↓
```

```
UNITS 49-64 AREAS:
1 2 3 4 5 6 7 8 0=CLR ↓
```

```
UNITS 65-80 AREAS:
1 2 3 4 5 6 7 8 0=CLR ↓
```

```
UNITS 81-96 AREAS:
1 2 3 4 5 6 7 8 0=CLR ↓
```

```
UNITS 97-112 AREAS:
1 2 3 4 5 6 7 8 0=CLR ↓
```

```
UNITS 113-128 AREAS:
1 2 3 4 5 6 7 8 0=CLR ↓
```

```
UNITS 129-144 AREAS:
1 2 3 4 5 6 7 8 0=CLR ↓
```

```
UNITS 145-160 AREAS:
1 2 3 4 5 6 7 8 0=CLR ↓
```

```
UNITS 161-176 AREAS:
1 2 3 4 5 6 7 8 0=CLR ↓
```

```
UNITS 177-192 AREAS:
1 2 3 4 5 6 7 8 0=CLR ↓
```

```
UNITS 193-208 AREAS:
1 2 3 4 5 6 7 8 0=CLR ↓
```

```
UNITS 209-224 AREAS:
1 2 3 4 5 6 7 8 0=CLR ↓
```

```
UNITS 225-240 AREAS:
1 2 3 4 5 6 7 8 0=CLR ↓
```

```
UNITS 241-256 AREAS:
1 2 3 4 5 6 7 8 0=CLR ↓
```

#### EXPANSION ENCLOSURE UNITS

```
UNITS 257-260 AREAS:
1 2 3 4 5 6 7 8 0=CLR ↓
```

```
UNITS 261-264 AREAS:
1 2 3 4 5 6 7 8 0=CLR ↓
```

```
UNITS 265-268 AREAS:
1 2 3 4 5 6 7 8 0=CLR ↓
```

```
UNITS 269-272 AREAS:
1 2 3 4 5 6 7 8 0=CLR ↓
```

```
UNITS 273-276 AREAS:
1 2 3 4 5 6 7 8 0=CLR ↓
```

```
UNITS 277-280 AREAS:
1 2 3 4 5 6 7 8 0=CLR ↓
```

```
UNITS 280-284 AREAS:
1 2 3 4 5 6 7 8 0=CLR ↓
```

```
UNITS 285-288 AREAS:
1 2 3 4 5 6 7 8 0=CLR ↓
```

```
UNITS 289-292 AREAS:
1 2 3 4 5 6 7 8 0=CLR ↓
```

```
UNITS 293-296 AREAS:
1 2 3 4 5 6 7 8 0=CLR ↓
```

```
UNITS 297-300 AREAS:
1 2 3 4 5 6 7 8 0=CLR ↓
```

```
UNITS 301-304 AREAS:
1 2 3 4 5 6 7 8 0=CLR ↓
```

```
UNITS 305-308 AREAS:
1 2 3 4 5 6 7 8 0=CLR ↓
```

UNITS 309-312 AREAS:  
 1 2 3 4 5 6 7 8 0=CLR ↓  
 UNITS 313-316 AREAS:  
 1 2 3 4 5 6 7 8 0=CLR ↓  
 UNITS 317-320 AREAS:  
 1 2 3 4 5 6 7 8 0=CLR ↓  
 UNITS 321-324 AREAS:  
 1 2 3 4 5 6 7 8 0=CLR ↓  
 UNITS 325-328 AREAS:  
 1 2 3 4 5 6 7 8 0=CLR ↓  
 UNITS 329-332 AREAS:  
 1 2 3 4 5 6 7 8 0=CLR ↓  
 UNITS 333-336 AREAS:  
 1 2 3 4 5 6 7 8 0=CLR ↓  
 UNITS 337-340 AREAS:  
 1 2 3 4 5 6 7 8 0=CLR ↓  
 UNITS 341-344 AREAS:  
 1 2 3 4 5 6 7 8 0=CLR ↓  
 UNITS 345-348 AREAS:  
 1 2 3 4 5 6 7 8 0=CLR ↓  
 UNITS 349-352 AREAS:  
 1 2 3 4 5 6 7 8 0=CLR ↓  
 UNITS 353-356 AREAS:  
 1 2 3 4 5 6 7 8 0=CLR ↓  
 UNITS 357-360 AREAS:  
 1 2 3 4 5 6 7 8 0=CLR ↓  
 UNITS 361-364 AREAS:  
 1 2 3 4 5 6 7 8 0=CLR ↓  
 UNITS 365-368 AREAS:  
 1 2 3 4 5 6 7 8 0=CLR ↓

UNITS 369-372 AREAS:  
 1 2 3 4 5 6 7 8 0=CLR ↓  
 UNITS 373-376 AREAS:  
 1 2 3 4 5 6 7 8 0=CLR ↓  
 UNITS 377-380 AREAS:  
 1 2 3 4 5 6 7 8 0=CLR ↓  
 UNITS 381-384 AREAS:  
 1 2 3 4 5 6 7 8 0=CLR ↓  
**CONTROLLER OUTPUT UNITS**  
 UNITS 385 AREAS:  
 1 2 3 4 5 6 7 8 0=CLR ↓  
 UNITS 386 AREAS:  
 1 2 3 4 5 6 7 8 0=CLR ↓  
 UNITS 387 AREAS:  
 1 2 3 4 5 6 7 8 0=CLR ↓  
 UNITS 388 AREAS:  
 1 2 3 4 5 6 7 8 0=CLR ↓  
 UNITS 389 AREAS:  
 1 2 3 4 5 6 7 8 0=CLR ↓  
 UNITS 390 AREAS:  
 1 2 3 4 5 6 7 8 0=CLR ↓  
 UNITS 391 AREAS:  
 1 2 3 4 5 6 7 8 0=CLR ↓  
 UNITS 392 AREAS:  
 1 2 3 4 5 6 7 8 0=CLR ↓  
**FLAG UNITS**  
 UNITS 393-400 AREAS:  
 1 2 3 4 5 6 7 8 0=CLR ↓

UNITS 401-408 AREAS:  
 1 2 3 4 5 6 7 8 0=CLR ↓  
 UNITS 409-416 AREAS:  
 1 2 3 4 5 6 7 8 0=CLR ↓  
 UNITS 417-424 AREAS:  
 1 2 3 4 5 6 7 8 0=CLR ↓  
 UNITS 425-432 AREAS:  
 1 2 3 4 5 6 7 8 0=CLR ↓  
 UNITS 433-440 AREAS:  
 1 2 3 4 5 6 7 8 0=CLR ↓  
 UNITS 441-448 AREAS:  
 1 2 3 4 5 6 7 8 0=CLR ↓  
 UNITS 449-456 AREAS:  
 1 2 3 4 5 6 7 8 0=CLR ↓  
 UNITS 457-464 AREAS:  
 1 2 3 4 5 6 7 8 0=CLR ↓  
 UNITS 465-472 AREAS:  
 1 2 3 4 5 6 7 8 0=CLR ↓  
 UNITS 473-480 AREAS:  
 1 2 3 4 5 6 7 8 0=CLR ↓  
 UNITS 481-488 AREAS:  
 1 2 3 4 5 6 7 8 0=CLR ↓  
 UNITS 489-496 AREAS:  
 1 2 3 4 5 6 7 8 0=CLR ↓  
 UNITS 497-504 AREAS:  
 1 2 3 4 5 6 7 8 0=CLR ↓  
 UNITS 505-511 AREAS:  
 1 2 3 4 5 6 7 8 0=CLR ↑

**SETUP AREAS: ZONES**

To assign zones to areas, from the Setup Areas menu, press 2 (ZONE). Each zone must be assigned to one and only one area.

ZONE 1 AREA:                   1  
 1-8                               ↓

THROUGH

ZONE 176 AREA                 1  
 1-8                               ↑

## SETUP AREAS: BUTTONS

To assign groups of macro buttons to specific areas, from the Setup Areas menu, press the 3 (BTNN) key.

Buttons can be configured so that they can only be activated from a particular area or from any area. Buttons are assigned to areas in groups of eight.

BUTTONS 1-8 AREAS: 1 2                   0=CLR ↓	BUTTONS 49-56 AREAS: 1 2                   0=CLR ↓	BUTTONS 97-104 AREAS: 1 2                   0=CLR ↓
BUTTONS 9-16 AREAS: 1 2                   0=CLR ↓	BUTTONS 57-64 AREAS: 1 2                   0=CLR ↓	BUTTONS 105-112 AREAS: 1 2                   0=CLR ↓
BUTTONS 17-24 AREAS: 1 2                   0=CLR ↓	BUTTONS 65-72 AREAS: 1 2                   0=CLR ↓	BUTTONS 113-120 AREAS: 1 2                   0=CLR ↓
BUTTONS 25-32 AREAS: 1 2                   0=CLR ↓	BUTTONS 73-80 AREAS: 1 2                   0=CLR ↓	BUTTONS 121-128 AREAS: 1 2                   0=CLR ↓
BUTTONS 33-40 AREAS: 1 2                   0=CLR ↓	BUTTONS 81-88 AREAS: 1 2                   0=CLR ↓	
BUTTONS 41-48 AREAS: 1 2                   0=CLR ↓	BUTTONS 89-96 AREAS: 1 2                   0=CLR ↓	

## SETUP AREAS: CONSOLES

To assign a console to an area, from the Setup Areas menu, press the 4 (CONS) key.

Each console must be assigned to one and only one area. A console may be set to global, which allows it to access areas other than its assigned area through security arming and the "go to" function.

CONSOLE 1 AREA:	1
1-8	↓
CONSOLE 1 GLOBAL:	1
0=NO 1=YES	↓

THROUGH

CONSOLE 16 AREA: 1	
1-8	↓
CONSOLE 16 GLOBAL:	1
0=NO 1=YES	↑

## SET-UP AREAS: THERMOSTATS

To assign thermostats to specific areas, from the Set-up Areas menu, press the 5 (TEMP) key.

Thermostats can be set up so that they can only be controlled from a specific area or from all areas. PESMs and Temperature Sensors can only be controlled from a single area, as specified in SETUP AREAS.

THERMOSTAT 1 AREAS:  
1 2 3 4 5 6 7 8 0=CLR ↓

THROUGH

THERMOSTAT 64 AREAS:  
1 2 3 4 5 6 7 8 0=CLR ↑

## SETUP AREAS: MESSAGES

To assign messages to specific areas, from the Setup Areas menu, press the 8 (MSG) key.

Messages can be setup so that they can be displayed in a specific area or in all areas.

MESSAGES 1-8 AREAS:  
1 2 3 4 5 6 7 8 0=CLR ↓

MESSAGES 49-56 AREAS:  
1 2 3 4 5 6 7 8 0=CLR ↓

MESSAGES 97-104 AREAS:  
1 2 3 4 5 6 7 8 0=CLR ↓

MESSAGES 9-16 AREAS:  
1 2 3 4 5 6 7 8 0=CLR ↓

MESSAGES 57-64 AREAS:  
1 2 3 4 5 6 7 8 0=CLR ↓

MESSAGES 105-112 AREAS:  
1 2 3 4 5 6 7 8 0=CLR ↓

MESSAGES 17-24 AREAS:  
1 2 3 4 5 6 7 8 0=CLR ↓

MESSAGES 65-72 AREAS:  
1 2 3 4 5 6 7 8 0=CLR ↓

MESSAGES 113-120 AREAS:  
1 2 3 4 5 6 7 8 0=CLR ↓

MESSAGES 25-32 AREAS:  
1 2 3 4 5 6 7 8 0=CLR ↓

MESSAGES 73-80 AREAS:  
1 2 3 4 5 6 7 8 0=CLR ↓

MESSAGES 121-128 AREAS:  
1 2 3 4 5 6 7 8 0=CLR ↓

MESSAGES 33-40 AREAS:  
1 2 3 4 5 6 7 8 0=CLR ↓

MESSAGES 81-88 AREAS:  
1 2 3 4 5 6 7 8 0=CLR ↓

MESSAGES 41-48 AREAS:  
1 2 3 4 5 6 7 8 0=CLR ↓

MESSAGES 89-96 AREAS:  
1 2 3 4 5 6 7 8 0=CLR ↓

## SETUP TEMPERATURES

To configure temperatures from the Installer Setup Menu, press the 5 (Temp) key.

### TEMPERATURE DISPLAY

This allows you to choose between Fahrenheit and Celsius temperature format.

```
TEMPERATURE DISPLAY:    1
1=FAHRENHEIT 2=CELSIUS ↓
```

### THERMOSTAT TYPE

If HAI thermostats are part of the system, this item specifies the thermostat type for each thermostat (this enables the thermostat). If thermostats are used, they must be configured to the applicable thermostat type. When any THERMOSTAT TYPE is changed from the default setting of "Not Used", Zone 16 and Output 8 is automatically configured for thermostats. There is no need to change the ZONE TYPE for Zone 16 or OUTPUT TYPE for Output 8.

For thermostat types, the current setting is shown on the bottom line.

```
THERMOSTAT 1 TYPE:      0
NOT USED                #-CHNG ↓
```

### THROUGH

```
THERMOSTAT 64 TYPE:     0
NOT USED                #-CHNG ↑
```

To enable or change a thermostat type, press the '#' key. Use the arrow keys to scroll through the list of thermostat types, then press '#' to select a new type. The display shows:

```
SELECT TYPE:            1
AUTO HEAT/COOL         ↓
```

TYPE	NUMBER	DESCRIPTION
AUTO HEAT/COOL	1	Automatic changeover heat and cool thermostat
HEAT/COOL	2	Manual changeover heat and cool thermostat
HEAT ONLY	3	Heating only thermostat
COOL ONLY	4	Cooling only thermostat
SETPOINT ONLY	5	Setpoint only thermostat

## SETUP MISCELLANEOUS

To configure the miscellaneous Installer Setup items, from the Installer Setup menu, press the 6 (MISC) key.

### INSTALLER CODE

The Installer code allows the installer access to the Installer Setup menu. The Installer code should be changed and not given to the customer. The Installer code cannot be used for remote phone access.

INSTALLER CODE:  
0000-9999 0000=DISABLE↓

The default setting for the Installer code is 1 1 1 1.

#### NOTE:

Remember this Installer code and do not disable. There is no way to reset or retrieve the code! If the code is forgotten or disabled, the OmniPro II controller must be sent back to the factory. Call for an RA#.

### ENABLE PC ACCESS

This enables or disables the PC ACCESS feature. Factory default is enabled.

ENABLE PC ACCESS: 1  
0=NO 1=YES ↓

### PC ACCESS CODE

This code allows dealers to put an access code in the system that is separate from the customer's Master code and the Installer code. Dealers can use the PC Access code to access the system by PC. The PC Access code cannot arm and disarm the system. The PC Access code is NOT programmed from the factory. To use it, set it to any code other than 0000. To disable the PC Access code, enter 0000 for the code.

NOTE: This item must be enabled (by entering a code) if PC Access is will be used.

PC ACCESS CODE:  
0000-9999 0000=DISABLE↑

### CALL BACK PHONE NUMBER

In response to a request for remote PC ACCESS using the PC ACCESS code, the system will hang up and dial this number back immediately. To program the CALLBACK PHONE NUMBER, enter the number then press '#'. To remove the CALLBACK PHONE NUMBER, press the OFF key to enter a single "-", then press '#'.  
-

CALL BACK PHONE NUMBER:  
- ↓

### OUTSIDE SIREN DELAY

If an output is configured as an "Exterior Sounder", when the alarm is "tripped", the interior sounder is turned on first. After the OUTSIDE SIREN DELAY, the outside sounder is turned on.

This feature helps reduce annoying false alarms by signaling inside the premises first. The outside siren delay is set to 15 seconds at the factory. You may change it to any value from 0 to 60 seconds. If you want the outside sounder to turn on immediately when the alarm is activated, set the delay to 0. We recommend a minimum time of 15 seconds.

DIAL OUT DELAY: 15  
0-60 SECONDS ↓

**DIAL OUT DELAY**

The DIAL OUT DELAY is the number of seconds that the OmniPro II waits before making an emergency dial out, AFTER the alarm is "tripped" (activated by burglar or fire). This delay is set at the factory to 15 seconds. We recommend a minimum time of 15 seconds to preclude an accidental activation of the alarm from calling in a false alarm.

DIAL OUT DELAY: 15  
0-60 SECONDS ↓

**ALARM RESET TIME**

The Alarm Reset Time is the time it takes before the alarm system resets itself after the alarm is tripped.

ALARM RESET TIME: 4  
1-30 MINUTES ↓

To change the alarm reset time, enter a new time between 1-30 minutes, then press the '#' key. The default setting is 4 minutes.

**ARMING CONFIRMATION**

The Arming Confirmation is a quick pulse (squawk) given by the outside siren when the alarm system is armed into a security mode and the EXIT DELAY is expired.

ARMING CONFIRMATION: 0  
0=NO 1=YES ↓

To enable the arming confirmation feature, press the 1 (YES) key, then press the '#' key. The default setting is 0 (NO) disabled.

**FIRE ALARM VERIFICATION**

This unit is equipped with a FIRE ALARM VERIFICATION feature. When a zone configured as a FIRE (Type 32) or a GAS (Type 34) is activated, the system will cycle SWITCH 12V and Switched Power Outputs off for 10 seconds. The SWITCH 12V power output will then be restored, and 5 seconds later, the zones will be monitored again. If the zone is activated again within a 2-minute window, the fire alarm will be activated. If not, no fire alarm will be indicated.

VERIFY FIRE ALARMS: 1  
0=NO 1=YES ↓

If VERIFY FIRE ALARMS is turned ON, **any** device (other than FIRE or GAS) connected to a SWITCH 12V Output (i.e. Glassbreak Detectors), must be connected to a zone configured as a LATCHING ZONE TYPE.

This feature is designed to reduce false alarms and is turned ON by factory default. The following notice is required by UL:

**WARNING**

This unit includes an alarm verification feature that will result in a delay of the system fire alarm signal from the initiating circuit. The total delay (OmniPro II controller plus detector delay) shall not exceed 60 seconds. No other initiating devices shall be connected to these circuits unless approved by the local authority having jurisdiction.

Zone Circuit	Control Unit Delay	Detector Model/Delay	Total Delay
_____	: 10 seconds	+ _____	= _____
_____	: 10 seconds	+ _____	= _____
_____	: 10 seconds	+ _____	= _____
_____	: 10 seconds	+ _____	= _____

## **SUPERVISE INT SNDR**

This enables or disables supervision of the Interior Horn Output, which monitors the wiring to the connected sirens. Factory default is disabled.

SUPERVISE INT SNDR: 0  
0=NO 1=YES ↓

## **SUPERVISE EXT SNDR**

This enables or disables supervision of the Exterior Horn Output, which monitors the wiring to the connected sirens. Factory default is disabled.

SUPERVISE EXT SNDR: 0  
0=NO 1=YES ↓

## **ENABLE EMERGENCY KEYS**

This enables or disables the functionality of the emergency keys on the console keypad. Factory default is enabled. Select the 1 (YES) key to enable the emergency keys. Select the 2 (NO) key to disable the emergency keys.

ENABLE EMERG KEYS: 1  
0=NO 1=YES ↓

## **TIME DISPLAY**

This allows you to choose between AM/PM and 24-HOUR time format.

TIME DISPLAY: 1  
1=AM/PM 2=24HR ↓

## **DATE DISPLAY**

This allows you to choose between MONTH/DAY and DAY/MONTH date format.

DATE DISPLAY: 1  
1=MMDD 2=DDMM ↓

## **AC POWER FREQUENCY**

Set this to the appropriate AC Powerline Frequency.

AC POWER FREQUENCY: 1  
1=60HZ 2=50HZ ↓

## **DEAD LINE DETECT**

NOTE: To disable OmniPro II from detecting a dead line, set this item to '0'; otherwise adjust only under direction of HAI.

This item adjusts the threshold that is used to determine when the phone line goes dead.

DEAD LINE DETECT: 8  
0-15 0=DISABLE ↓

## **OFF HOOK DETECT**

NOTE: Adjust only under direction of HAI.

This item adjusts the threshold that is used to determine when the phone line is going off hook.



OFF HOOK DETECT: 69  
20-250 ↓

### PICKUP AFTER HANGUP

This item is used to disable OmniPro II from picking up the phone line after the called party hangs up the line.

PICKUP AFTER HANGUP: 1  
0=NO 1=YES ↓

Currently, after the called party or the called party's answering machine hangs up the phone line, OmniPro II picks up the line and make its "Beep". If you wish to turn the Pickup After Hangup OFF, press 0 then '#'. To turn it back On, press 1 then '#'.

The default setting for Pickup After Hangup is Yes.

### CLOCK ADJUSTMENT

If the clock on an OmniPro II is running faster or slower than the actual time, you can have the OmniPro II automatically compensate up to 29 seconds per day. The OmniPro II will add or subtract the selected amount of time daily.

CLOCK ADJUSTMENT: 30  
1-59=-29 TO +29 SEC/DAY↑

Enter 1-29 to subtract 1-29 seconds. Enter 31-59 to add 1-29 seconds. Enter 30 for no adjustment to the clock.

The default setting is 30.

### MODEL AND SOFTWARE VERSION

Next, the model number and software version for the system is displayed:

HAI OMNIPRO II  
S/W VERSION 2.0 ↓

### RESET SYSTEM EEPROM

Select the 1 (YES) key to reset the EEPROM. All programs, names, and setup items will be reset. All system RAM will also be initialized and the system will restart. This option, if effect, allows the system to be restored to factory fresh configuration.

RESET SYSTEM EEPROM? 0  
0=NO 1=YES ↓

### RESET SYSTEM RAM

Select the 1 (YES) key to cause all of the system RAM to be reinitialized. The time, date, and event log will be cleared. Other volatile memory locations will also be reinitialized. The system RAM should only be reset if the system is acting strangely and memory corruption is suspected. Resetting the system RAM will not reset any setup items stored in EEPROM.

RESET SYSTEM RAM? 0  
0=NO 1=YES ↓

### ETHERNET MAC ADDRESS

The Ethernet MAC Address, short for Media Access Control address, is the hardware address that uniquely identifies OmniPro II when connected to a network.

ETHERNET MAC ADDRESS  
FF-FF-FF-FF-FF-FF ↑

## SETUP EXPANSION

To configure each Expansion Module that is installed on your system, from the Installer Setup menu, press the 7 (EXP) key.

Expansion Modules include Hardwire Zone Expanders, ALC Interface Modules, and Serial Interface Modules using either the Omni-Link or Pro-Link Protocol.

### MODULE 1 TYPE

The Module Type defines the function of each expansion module on the controller. Module 1 is the module with the ADDR jumper set to 1. Set the module type from the list below. Press '#' to change the module type, then use the arrow keys to select the proper module type, then press '#' to enter.

```
MODULE 1 TYPE          1
NOT USED              #=CHNG ↓
```

Select from the following for the module with jumper set to 1:

MODULE TYPES	NUMBER	DESCRIPTION
NOT USED	0	No module is installed
HARDWIRE EXPNDR	1	Model 10A06 Hardwire Expander installed
ALC	2	ALC Interface Module is installed
OMNI-LINK	3	Model 10A17 Serial Interface using the Omni-Link protocol
PRO-LINK	4	Model 10A17 Serial Interface using the Pro-Link protocol

#### Notes:

1. Only 2 Model 10A06 Hardwire Expander Modules can be installed.
2. Only 2 ALC Interface Modules can be installed.
3. Only 1 Serial Interface Module can be installed and configured (Omni-Link or Pro-Link). To configure the protocol for the built-in serial ports, set the "Serial 1 Function", "Serial 2 Function", and "Serial 3 Function" to the desired protocol.

### MODULE 2 TYPE - MODULE 4 TYPE

Module 2 is the module with the jumper set to 2, and so on. Set each module type from the list above.

### SERIAL 1 RATE

"Serial 1 Rate" selects the baud rate used for the built-in serial interface (J1 Serial) on the OmniPro II controller. Select the baud rate for the built-in serial interface from the list. Use the arrow keys to select the baud rate then press the '#' key.

BAUD RATE	NUMBER
75 baud	1
150 baud	2
300 baud	3
600 baud	4
1200 baud	5
2400 baud	6
4800 baud	7
9600 baud	8 (default)

### SERIAL 2 - SERIAL 3 RATE

"Serial 2 Rate" and "Serial 3 Rate" selects the baud rate used for the built-in serial interface ports (J2 Serial and J3 Serial, respectively) on the OmniPro II controller. Select the baud rate for the built-in serial interface from the list.

## SERIAL 1 FUNCTION

The "Serial 1 Function" selects the communication protocol used for the built-in serial interface (J1 Serial) on the OmniPro II controller. Select the function for the built-in serial interface from the list. Use the arrow keys to select the function then press the '#' key.

FUNCTION TYPES	NUMBER	DESCRIPTION
OMNI-LINK	3	Serial communication using the Omni-Link protocol
PRO-LINK	4	Serial communication using the Pro-Link protocol

## SERIAL 2 - SERIAL 3 FUNCTION

The "Serial 2 Function" and "Serial 3 Function" selects the communication protocol used for the built-in serial interface ports (J2 Serial and J3 Serial, respectively) on the OmniPro II controller. Select the function for the built-in serial interface from the list.

## SERIAL 4 RATE

"Serial 4 Rate" selects the baud rate used when a Serial Interface Module is added to the OmniPro II system. If a Serial Interface Module is installed, select its baud rate then press the '#' key.

BAUD RATE	NUMBER
75 baud	1
150 baud	2
300 baud	3
600 baud	4
1200 baud	5
2400 baud	6
4800 baud	7
9600 baud	8 (default)

## OMNIPRO II SPECIFICATIONS

Size: Controller: 13 W x 13 H x 4.5 D  
Console: 4.6 W x 4.5 H x 1.2 D

Weight: Controller: approx. 10 lb.  
Console: approx. 0.5 lb.

Operating Ranges: 32 - 122 degrees F (0 - 50 degrees C)  
10 - 95 % relative humidity, non-condensing

Power: 120 VAC, 60 Hz, 60 watts

Transformer: 24 VAC, 1.67 amps, 40 VA

Battery: Rechargeable Lead-Acid, 12 volts, 7 amp-hour

Device Fuse: Polyfuse: 1.35 A

Horns Fuse: Polyfuse: 1.35 A

Battery Fuse: Polyfuse: 4.00 A

Polyfuses are permanent fuses that do not need replacement.

Nominal Voltage: 10 - 13.7 VDC, 0.5 V max. peak to peak ripple

Low Voltage Cut Out: approx. 9 VDC

Typical Current Consumption at Nominal Voltage:

Controller: 135 mA  
Console: backlight off - 35 mA; backlight on - 100 mA

Controller Maximum Group Current Outputs:

Devices: AUX 12 VDC, SWITCH 12 VDC, CONSOLE, and OUTPUTS 1 - 8: 1 A

Horn: INT HORN and EXT HORN: 1 A

Controller Maximum Individual Current Outputs:

Devices: **(Do not exceed 1 A total)**

AUX 12 VDC	1 A
SWITCH 12 VDC	1 A
CONSOLE	1 A
OUTPUTS 1 - 8	100 mA

For 24-Hour Battery Standby Time, the following must be observed: (See Figure 15)

Controller Maximum Group Current Outputs (applies to residential and commercial):

Devices: AUX 12 VDC, SWITCH 12 VDC, CONSOLE, and OUTPUTS 1 - 8: 250mA

Horn: INT HORN and EXT HORN: 300mA

# UNDERWRITER'S LABORATORIES (UL) INSTALLATION REQUIREMENTS

The OmniPro II control units (20A00-2, -5, and -22) are suitable for Grade A household burglar and fire applications. Refer to UL1641 for installation requirements. Model 20A00-5 is also suitable for use in Commercial Burglar Alarm Applications, Grade B, C Central Station, Grade A Local, and Grade A Police Connect. Refer to UL 681 for Installation Requirements.

1. The line carrier (X-10) operation is considered supplementary. Operation of the line carrier devices was not investigated by UL.
2. For those zones programmed as PANIC, DURESS or POLICE EMERGENCY, the initiating device shall be a UL Listed Hold Up Device switch.
3. Connections to phone circuit must be made via the supplied cable and RJ31X Jack as shown under RJ31X JACK CONNECTIONS in this manual.
4. For connection of smoke detectors to the controller, refer to requirements under FIRE ZONE HOOKUP and FIRE ZONE CONNECTIONS diagrams in this manual.
5. The controller must be configured for 24 hour Standby Time as shown under 24 HR STANDBY CONNECTIONS diagram in this manual. Maximum current ratings for 24 hours must be observed.
6. Recognized energy limited cable shall be employed, 22 AWG minimum for all connections.
7. The audible signal appliance shall be the Listed Wheelock Model MT-12/24-R Multitone Signal, rated 10.5 - 15.6 VDC, 95 dB(A) with 2 reflecting planes. The audible signal shall be mounted indoors in a central location. The audible signal appliance can be connected to either the "INT HORN" or "EXT HORN" circuits. In the case of the latter, the OUTSIDE SIREN DELAY shall be set to 0 seconds.
8. For Residential Applications, the Model 10A01-1 Enclosure shall be used.
9. For Commercial Applications, the Model 10A02-2 Commercial Enclosure shall be used.
10. For Commercial Applications, Listed Ademco AB12 Bell and housing to be used.
11. If the remote arm/disarm switch is used, it shall be the Listed Ademco Model 9789.
12. Operation of the controls with the Programmable Energy Saver Module was not conducted by UL.
13. Operation of the Model 12A00 Wireless Receiver was not verified by UL.
14. Operation of the Two-Way Audio Module was not verified by UL.
15. RS-232 and RS-485 communications were not verified by UL.
16. Refer to the OmniPro II Owner's Manual (Document No. 20R00-2) for programming requirements in UL Listed Installations.
17. For the monitoring of burglar alarm initiating devices, the zone type shall provide an audible output (i.e., not DURESS).
18. The Omni controller must be connected (when employed) to listed carbon monoxide gas detectors (i.e. Sentrol -Model 240-CO).
19. All connections to energy sensors and modules must be done to listed Class 2 circuits only.
20. The OmniPro II must be used in Residential Applications that are under a single ownership.

When used in UL Listed Installations, the following items apply:

1. The "High Security Mode" must be ON.
2. The "Enable Auto Bypass" feature must be OFF.
3. The "Zone Resistors" must be YES.
4. The "Supervise Int Horn" must be YES.
5. The ENTRY DELAY SHALL NOT EXCEED 45 SECONDS for Residential Applications; 60 seconds for Commercial Applications.
6. The EXIT DELAY shall not exceed 60 seconds.
7. Double Delay and Quad Delay zone types shall not be used.
8. The BEEP ON TROUBLE feature must be ON.
9. For Residential Applications the sounding device may be mounted indoors. If, however, the sounding device is connected to the "EXT HORN" terminals of the OmniPro II, then the OUTSIDE SIREN DELAY shall be set to 0.

Installer: NAME: \_\_\_\_\_

NUMBER: \_\_\_\_\_

# 24-HOUR STANDBY BATTERY CAPACITY

## Maximum current ratings for 24-hours:

Aux 12 VDC, Switch 12 VDC, Console, and Outputs 1-8: 250 mA

Interior Horn and Exterior Horn: 350 mA

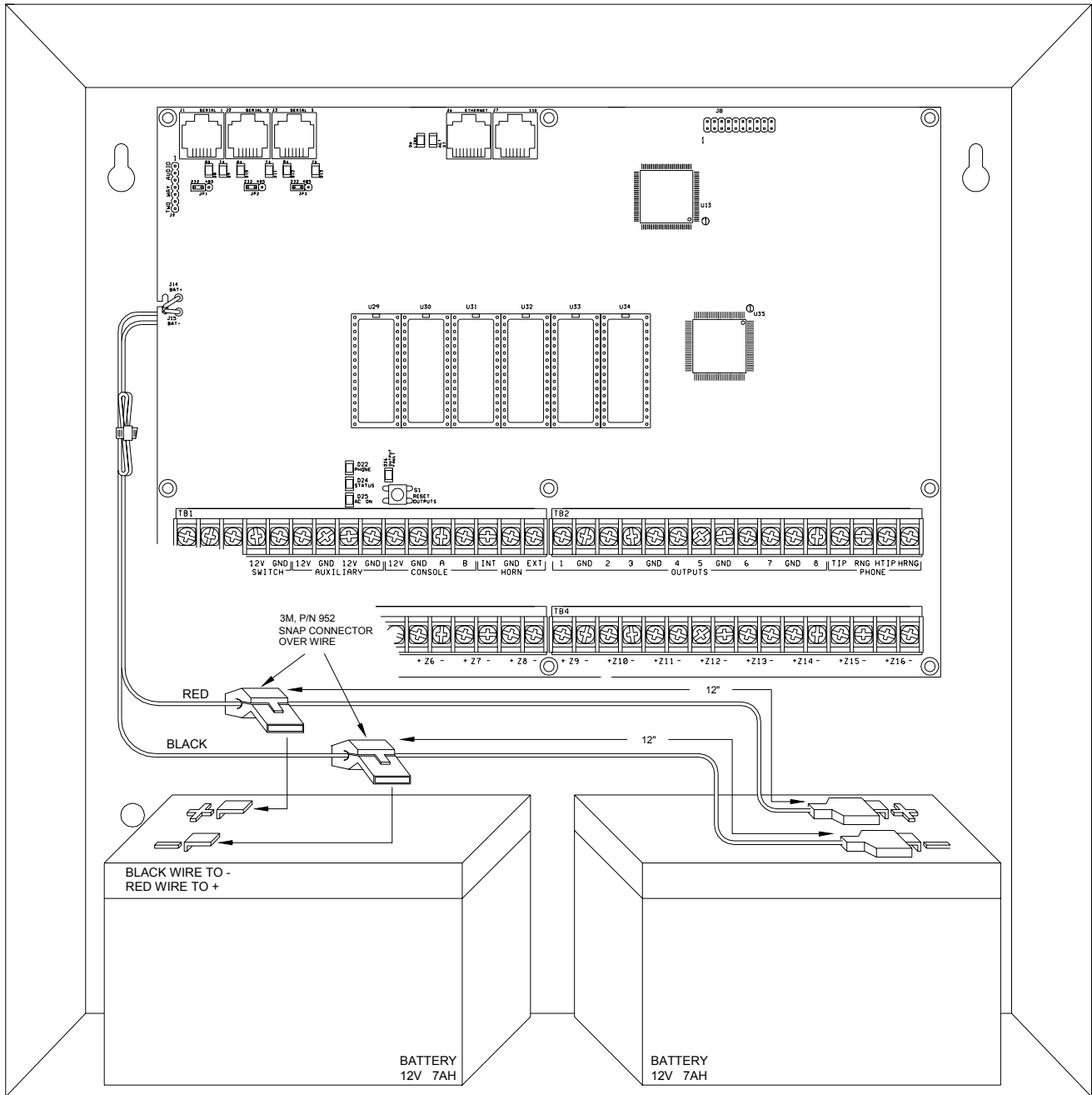

**FIGURE 17 - 24-HOUR STANDBY CONNECTIONS**

# SMOKE DETECTOR INSTALLATION GUIDELINES

1. Ceiling mounted smoke detectors should be located in the center of the room or hall, or not less than 4 inches from any wall. When the detector is mounted on a wall, the top of the detector should be 4 to 12 inches from the ceiling.
2. Do not install smoke detectors where normal ambient temperatures are above 100 deg. F (37.8 deg. C) or below 40 deg. F (4 deg. C). Also, do not locate the detector in front of air conditioners, heating registers, or other locations where normal air circulation will keep smoke from entering the detector.
3. Additional information on Household Fire Warning is available at nominal cost from: The National Fire Protection Association, Battery March Park, Quincy, MA. 02269. Request Standard No. NFPA 72. Contact your home Insurance Company for a possible reduction of your insurance premium.
4. A smoke detector should be located between the sleeping area and the rest of the family living unit.
5. In family living units with more than one sleeping area, a smoke detector should be provided to protect each sleeping area.
6. A smoke detector should be located on each story (Refer to the diagrams below).
7. For complete details on proper location and installation of smoke detectors, refer to the instructions supplied with the smoke detector.

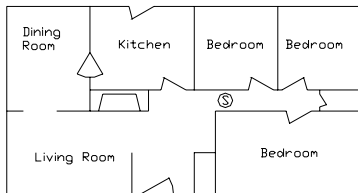

(a) A smoke detector should be located between the sleeping area and the rest of the family living unit.

(b) Where to Locate the Required Smoke Detectors in New Construction. All of the smoke detectors specified in (a) for existing construction are required, and, in addition, a smoke detector is required in each bedroom.

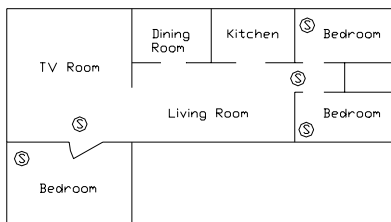

(b) In family living units with more than one sleeping area, a smoke detector should be provided to protect each sleeping area in addition to detectors required in bedrooms.

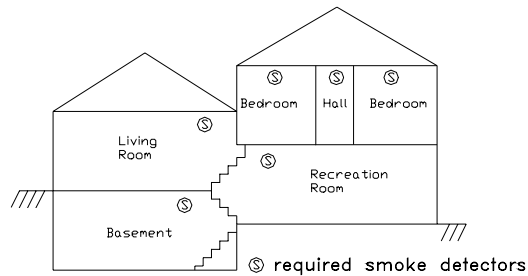

Split level arrangement. Smoke detectors are required where shown. Smoke detectors are optional if door is not provided between living and recreation rooms.

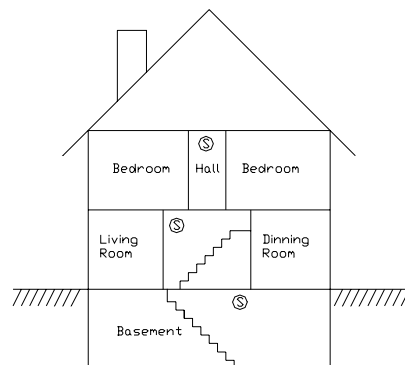

A smoke detector should be located on each story.

## APPENDIX A – CONTACT ID REPORTING FORMAT

ZONE TYPE	TRIP	TROUBLE	DESCRIPTION
Entry/exit (also Double & Quad)	134	370	Entry/exit burglary
Perimeter (also Latching)	131	370	Perimeter burglary
Night Interior (also Latching)	132	370	Interior burglary
Away Interior (also Latching)	132	370	Interior burglary
Panic	120	375	Panic alarm
Police Emergency	120	375	Panic alarm
Silent Duress	122	375	Silent panic
Tamper (also Latching)	137	370	Tamper burglary
Fire	110	373	Fire alarm
Fire Emergency	110	373	Fire alarm
Gas	151	373	Gas alarm
Auxiliary Emergency	150	370	24 hour non-burglary
Trouble	330	330	System peripheral trouble
Freeze	159	370	Low temperature alarm
Water	154	370	Water leakage
Auxiliary	none	none	none
Fire tamper	321	321	Bell/siren #1 trouble
Temperature Alarm	152	370	Refrigeration alarm

EVENT	CODE	DESCRIPTION
Zone bypass/restore	570	Zone bypass/restore
Fire zone bypass/restore	571	Fire bypass/restore
Automatic communicator test	602	Periodic test
Cancel	406	Cancel
User disarm/arm	401	Open/close by user
Programmed disarm/arm	403	Automatic open/close
PC Access disarm/arm	407	Remote open/close
Quick arm	408	Closing-quick arm
Keyswitch disarm/arm	409	Keyswitch open/close

SYSTEM TROUBLE	CODE	DESCRIPTION
Battery low	302	Low system battery
Fuse	312	Power supply overcurrent
AC power failure	301	AC power loss
Phone line dead	351	Phone line #1 trouble
Digital communicator	350	Communication failure
Fire tamper	321	Bell/siren #1 trouble



# APPENDIX B - DIGITAL COMMUNICATOR CODE SHEET

## INFORMATION FOR CENTRAL STATION

Date: \_\_\_\_\_

Subscriber Name: \_\_\_\_\_  
Address 1: \_\_\_\_\_  
Address 2: \_\_\_\_\_  
City, State, Zip: \_\_\_\_\_  
Home #: \_\_\_\_\_ Work #: \_\_\_\_\_  
Password: \_\_\_\_\_

Installer Name: \_\_\_\_\_  
Address 1: \_\_\_\_\_  
Address 2: \_\_\_\_\_  
City, State, Zip: \_\_\_\_\_  
Phone #: \_\_\_\_\_ Beeper #: \_\_\_\_\_

### Subscriber's Notification List:

1. Name: \_\_\_\_\_  
Phone #: \_\_\_\_\_  
Relationship: \_\_\_\_\_
2. Name: \_\_\_\_\_  
Phone #: \_\_\_\_\_  
Relationship: \_\_\_\_\_
3. Name: \_\_\_\_\_  
Phone #: \_\_\_\_\_  
Relationship: \_\_\_\_\_

Subscriber Equipment: **Home Automation, Inc. - OmniPro II**

Notes: \_\_\_\_\_  
\_\_\_\_\_  
\_\_\_\_\_

First Phone #: \_\_\_\_\_  
First Account #: \_\_\_\_\_  
Second (Backup) Phone #: \_\_\_\_\_  
Second (Backup) Account #: \_\_\_\_\_

Communicator Type (Contact ID, 1400 Hz, or 2300 Hz): \_\_\_\_\_

TWO-WAY AUDIO: \_\_\_\_\_ YES \_\_\_\_\_ NO  
REPORT OPEN/CLOSE: \_\_\_\_\_ YES \_\_\_\_\_ NO

24 HOUR TEST: \_\_\_\_\_ YES \_\_\_\_\_ NO TEST TIME: \_\_\_\_\_

<b>CODE</b>	<b>ZONE</b>	<b>DESCRIPTION</b>	<b>ACTION TO TAKE</b>
98	TEST CODE		
01	ZONE 1:		
02	ZONE 2:		
03	ZONE 3:		
04	ZONE 4:		
05	ZONE 5:		
06	ZONE 6:		
07	ZONE 7:		
08	ZONE 8:		
09	ZONE 9:		
10	ZONE 10:		
11	ZONE 11:		
12	ZONE 12:		
13	ZONE 13:		
14	ZONE 14:		
15	ZONE 15:		
16	ZONE 16:		
17	ZONE 17:		
18	ZONE 18:		
19	ZONE 19:		
20	ZONE 20:		
21	ZONE 21:		
22	ZONE 22:		
23	ZONE 23:		
24	ZONE 24:		
25	ZONE 25:		
26	ZONE 26:		
27	ZONE 27:		
28	ZONE 28:		
29	ZONE 29:		
30	ZONE 30:		
31	ZONE 31:		
32	ZONE 32:		
B0	ZONE 33:		
B1	ZONE 34:		
B2	ZONE 35:		
B3	ZONE 36:		
B4	ZONE 37:		
B5	ZONE 38:		
B6	ZONE 39:		
B7	ZONE 40:		
B8	ZONE 41:		
B9	ZONE 42:		
BB	ZONE 43:		
BC	ZONE 44:		
BD	ZONE 45:		
BE	ZONE 46:		
BF	ZONE 47:		
C0	ZONE 48:		
C1	ZONE 49:		
C2	ZONE 50:		
C3	ZONE 51:		
C4	ZONE 52:		
C5	ZONE 53:		
C6	ZONE 54:		
C7	ZONE 55:		
C8	ZONE 56:		
C9	ZONE 57:		

<b>CODE</b>	<b>ZONE</b>	<b>DESCRIPTION</b>	<b>ACTION TO TAKE</b>
CB	ZONE 58:		
CC	ZONE 59:		
CD	ZONE 60:		
CE	ZONE 61:		
CF	ZONE 62:		
D0	ZONE 63:		
D1	ZONE 64:		
D2	ZONE 65:		
D3	ZONE 66:		
D4	ZONE 67:		
D5	ZONE 68:		
D6	ZONE 69:		
D7	ZONE 70:		
D8	ZONE 71:		
D9	ZONE 72:		
DB	ZONE 73:		
DC	ZONE 74:		
DD	ZONE 75:		
DE	ZONE 76:		
DF	ZONE 77:		
E0	ZONE 78:		
E1	ZONE 79:		
E2	ZONE 80:		
E3	ZONE 81:		
E4	ZONE 82:		
E5	ZONE 83:		
E6	ZONE 84:		
E7	ZONE 85:		
E8	ZONE 86:		
E9	ZONE 87:		
EB	ZONE 88:		
EC	ZONE 89:		
ED	ZONE 90:		
EE	ZONE 91:		
EF	ZONE 92:		
F0	ZONE 93:		
F1	ZONE 94:		
F2	ZONE 95:		
F3	ZONE 96:		
0B	ZONE 97:		
0C	ZONE 98:		
0D	ZONE 99:		
0E	ZONE 100:		
0F	ZONE 101:		
1B	ZONE 102:		
1C	ZONE 103:		
1D	ZONE 104:		
1E	ZONE 105:		
1F	ZONE 106:		
2B	ZONE 107:		
2C	ZONE 108:		
2D	ZONE 109:		
2E	ZONE 110:		
2F	ZONE 111:		
33	ZONE 112:		
34	ZONE 113:		

<b>CODE</b>	<b>ZONE</b>	<b>DESCRIPTION</b>	<b>ACTION TO TAKE</b>
35	ZONE 114:		
36	ZONE 115:		
37	ZONE 116:		
38	ZONE 117:		
39	ZONE 118:		
3B	ZONE 119:		
3C	ZONE 120:		
3D	ZONE 121:		
3E	ZONE 122:		
3F	ZONE 123:		
4B	ZONE 124:		
4C	ZONE 125:		
4D	ZONE 126:		
4E	ZONE 127:		
4F	ZONE 128:		
57	ZONE 129:		
58	ZONE 130:		
58	ZONE 131:		
5B	ZONE 132:		
5C	ZONE 133:		
5D	ZONE 134:		
5E	ZONE 135:		
5F	ZONE 136:		
6B	ZONE 137:		
6C	ZONE 138:		
6D	ZONE 139:		
6E	ZONE 140:		
6F	ZONE 141:		
77	ZONE 142:		
78	ZONE 143:		
79	ZONE 144:		
7B	ZONE 145:		
7C	ZONE 146:		
7D	ZONE 147:		
7E	ZONE 148:		
7F	ZONE 149:		
80	ZONE 150:		
88	ZONE 151:		
89	ZONE 152:		
8B	ZONE 153:		
8C	ZONE 154:		
8D	ZONE 155:		
8E	ZONE 156:		
8F	ZONE 157:		
90	ZONE 158:		
91	ZONE 159:		
92	ZONE 160:		
93	ZONE 161:		
94	ZONE 162:		
95	ZONE 163:		
96	ZONE 164:		
97	ZONE 165:		
9B	ZONE 166:		
9C	ZONE 167:		
9D	ZONE 168:		
9E	ZONE 169:		
9F	ZONE 170:		
F4	ZONE 171:		

<b>CODE</b>	<b>ZONE</b>	<b>DESCRIPTION</b>	<b>ACTION TO TAKE</b>
F5	ZONE 172:		
F6	ZONE 173:		
F7	ZONE 174:		
F8	ZONE 175:		
F9	ZONE 176:		
81	FREEZE ALARM		
82	FIRE EMERG		
83	POLICE EMERG		
84	AUX EMERG		
85	DURESS		
86	BATTERY LOW		
87	FIRE TROUBLE		
99	CANCEL CODE		
40	OTHER OPEN		
41	USER 1 OPEN		
42	USER 2 OPEN		
43	USER 3 OPEN		
44	USER 4 OPEN		
45	USER 5 OPEN		
46	USER 6 OPEN		
47	USER 7 OPEN		
48	USER 8 OPEN		
49	USER 9 OPEN		
50	USER 10 OPEN		
51	USER 11 OPEN		
52	USER 12 OPEN		
53	USER 13 OPEN		
54	USER 14 OPEN		
55	USER 15 OPEN		
56	USER 16 OPEN		
60	OTHER CLOSE		
61	USER 1 CLOSE		
62	USER 2 CLOSE		
63	USER 3 CLOSE		
64	USER 5 CLOSE		
65	USER 5 CLOSE		
66	USER 6 CLOSE		
67	USER 7 CLOSE		
68	USER 8 CLOSE		
69	USER 9 CLOSE		
70	USER 10 CLOSE		
71	USER 11 CLOSE		
72	USER 12 CLOSE		
73	USER 13 CLOSE		
74	USER 14 CLOSE		
75	USER 15 CLOSE		
76	USER 16 CLOSE		

## APPENDIX C - ZONE AND UNIT MAPPING

<b>ZONE</b>	<b>DEVICE</b>
Zones 1-16	Zones 1-16 on Controller
Zones 17-32	Zones 1-16 on 1st Model 10A06 Hardwire Expander
Zones 33-48	Zones 1-16 on 2nd Model 10A06 Hardwire Expander
Zones 49-64	Zones 1-16 on 1st Model 17A00 Expansion Enclosure
Zones 65-80	Zones 1-16 on 2nd Model 17A00 Expansion Enclosure
Zones 81-96	Zones 1-16 on 3rd Model 17A00 Expansion Enclosure
Zones 97-112	Zones 1-16 on 4th Model 17A00 Expansion Enclosure
Zones 113-128	Zones 1-16 on 5th Model 17A00 Expansion Enclosure
Zones 129-144	Zones 1-16 on 6th Model 17A00 Expansion Enclosure
Zones 145-160	Zones 1-16 on 7th Model 17A00 Expansion Enclosure
Zones 161-176	Zones 1-16 on 8th Model 17A00 Expansion Enclosure

<b>UNITS</b>	<b>MODULES / OUTPUTS / FLAGS</b>
Units 1-16	X-10 modules 1 - 16, House Code X
Units 17-32	X-10 modules 1 - 16, House Code X+1
Units (1-31)	ALC addresses 1-31, Module 1 - Branch 1
Units 33-48	X-10 modules 1 - 16, House Code X+2
Units 49-64	X-10 modules 1 - 16, House Code X+3
Units (33-63)	ALC addresses 1-31, Module 1 - Branch 2
Units 65-95	X-10 modules 1 - 16, House Code X+4
Units 81-96	X-10 modules 1 - 16, House Code X+5
Units (65-95)	ALC addresses 1-31, Module 1 - Branch 3
Units 97-112	X-10 modules 1 - 16, House Code X+6
Units 113-128	X-10 modules 1 - 16, House Code X+7
Units (97-127)	ALC addresses 1-31, Module 1 - Branch 4
Units 129-144	X-10 modules 1 - 16, House Code X+8
Units 145-160	X-10 modules 1 - 16, House Code X+9
Units (129-159)	ALC addresses 1-31, Module 2 - Branch 1
Units 161-176	X-10 modules 1 - 16, House Code X+10
Units 177-192	X-10 modules 1 - 16, House Code X+11
Units (161-191)	ALC addresses 1-31, Module 2 - Branch 2
Units 193-208	X-10 modules 1 - 16, House Code X+12
Units 209-224	X-10 modules 1 - 16, House Code X+13
Units (193-223)	ALC addresses 1-31, Module 2 - Branch 3
Units 225-240	X-10 modules 1 - 16, House Code X+14
Units 241-256	X-10 modules 1 - 16, House Code X+15
Units (225-255)	ALC addresses 1-31, Module 2 - Branch 4
Units 257-272	Outputs 1-16, 1st Model 17A00 Expansion Enclosure
Units 273-288	Outputs 1-16, 2nd Model 17A00 Expansion Enclosure
Units 289-304	Outputs 1-16, 3rd Model 17A00 Expansion Enclosure
Units 305-320	Outputs 1-16, 4th Model 17A00 Expansion Enclosure
Units 321-336	Outputs 1-16, 5th Model 17A00 Expansion Enclosure
Units 337-352	Outputs 1-16, 6th Model 17A00 Expansion Enclosure
Units 353-368	Outputs 1-16, 7th Model 17A00 Expansion Enclosure
Units 369-384	Outputs 1-16, 8th Model 17A00 Expansion Enclosure
Units 385-392	Voltage Outputs (1-8) on Controller
Units 393-511	Flags





HAI • New Orleans, LA • U S A